



SERVICE INFORMATION	5-1
ENGINE REMOVAL	5-2
ENGINE INSTALLATION	5-7

SERVICE INFORMATION

• WORKING PRACTICE

Parts requiring engine removal for servicing:

- Crankshaft, Piston
- Connecting rods
- Camshafts
- Flywheel and starting clutch
- Gearshift spindle
- Transmission
- Water pump mechanical seal

Remove and install the engine with a hydraulic jack to support its weight.

ENGINE WEIGHT: 67 kg (148 lbs)



ENGINE REMOVAL

Turn the fuel valve off.
 Remove the seat and fuel tank.
 Remove the right and left side covers.
 Disconnect the battery ground and starter motor cables.
 Drain oil from the engine (Page 2-2).

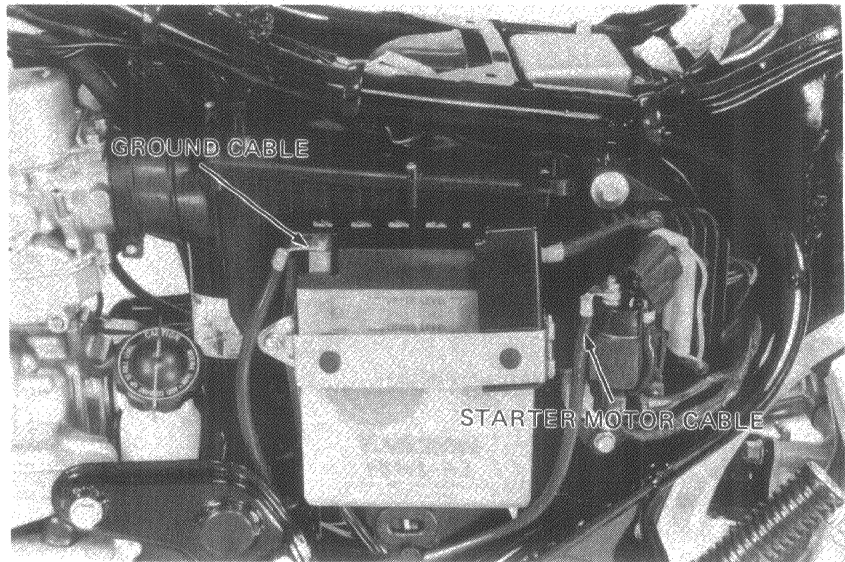

Loosen the 6 mm tachometer cable set bolt and pull the cable clear of the engine.
 Disconnect the radiator bypass hose from the radiator.
 Remove the breather hose.
 Disconnect the clutch cable at the upper adjuster and remove it from the wire guide.

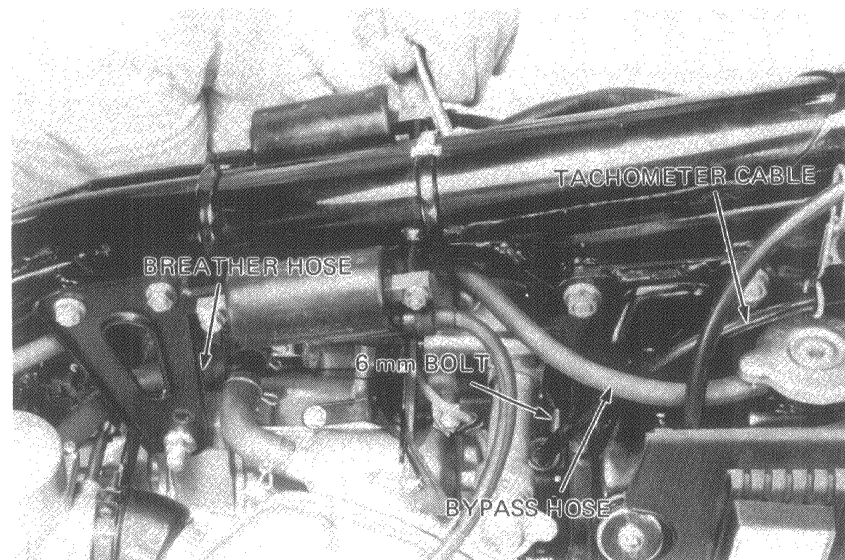

Disconnect the thermostatic switch wire (blue/red) and oil pressure gauge wire (green).
 Remove the spark plug caps from the spark plugs.
 Remove the 6 mm ignition coil mounting bolt at the rear.
 Remove the engine hanger bolts and hanger plates.

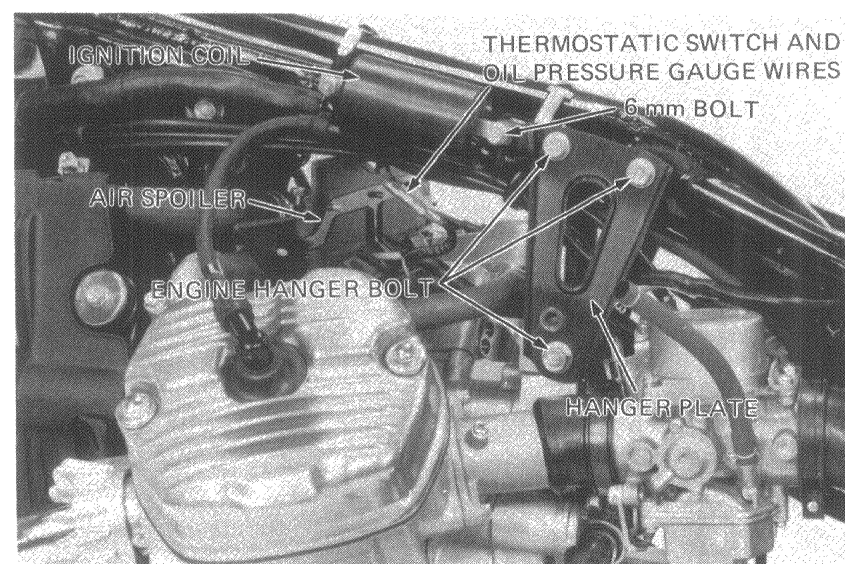



Remove the muffler mounting bolts.
Loosen the muffler clamp bolts, and remove
the exhaust mufflers.

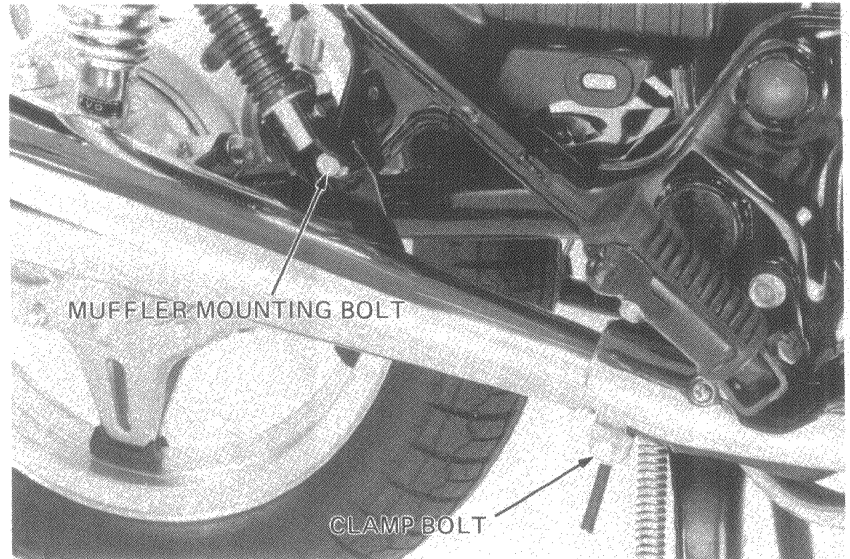

Remove the exhaust pipe clamp nuts.
Loosen the exhaust pipe clamp bolts and re-
move the exhaust pipes.
Loosen the carburetor band.

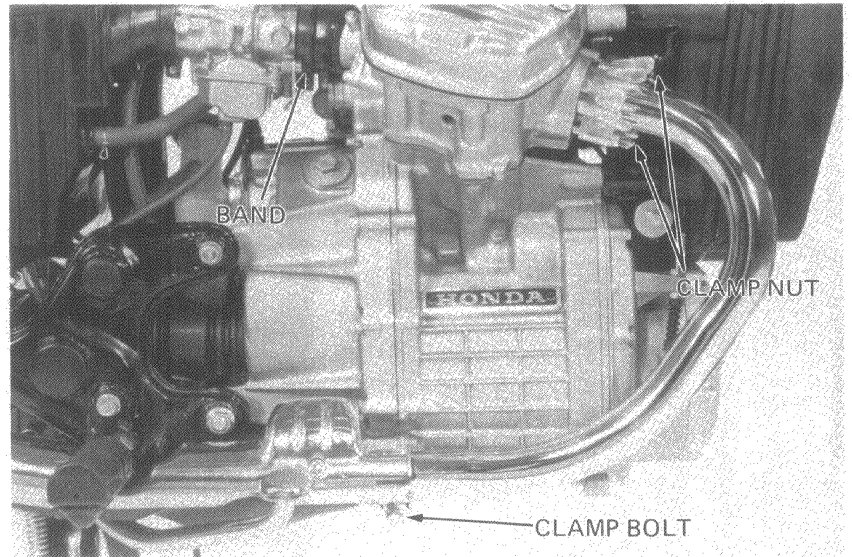

Remove the rear brake adjusting nut.
Remove the rear brake pedal return spring.

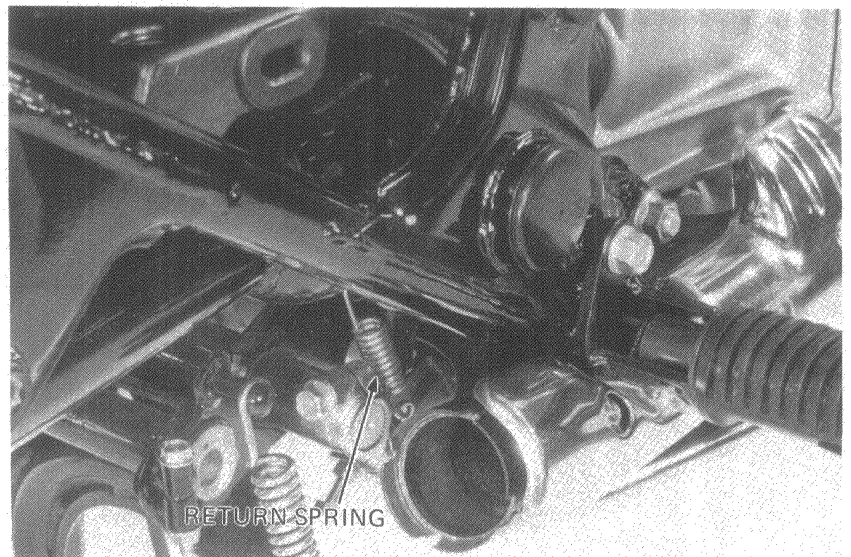



Remove the power chamber bolts.
Remove the power chamber.

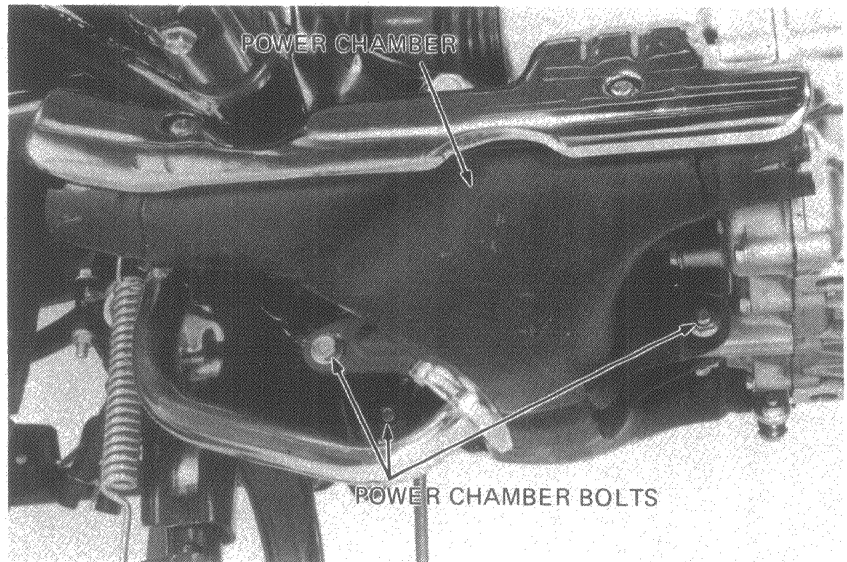

Remove the wire harness bands.
Disconnect the C.D.I. unit and A.C. generator cables at the couplers.
Disconnect the ignition coil cords.
Pull the wire harnesses clear of the frame.

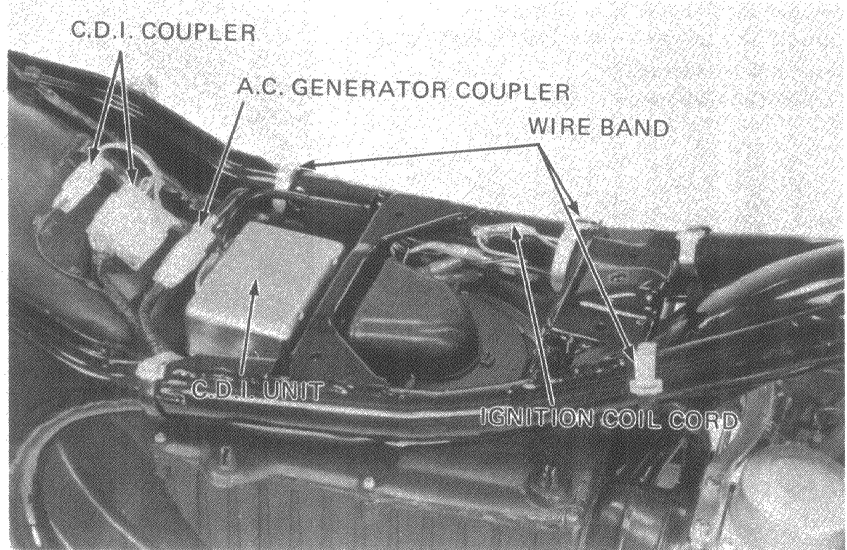

Remove the drive shaft lock bolt.

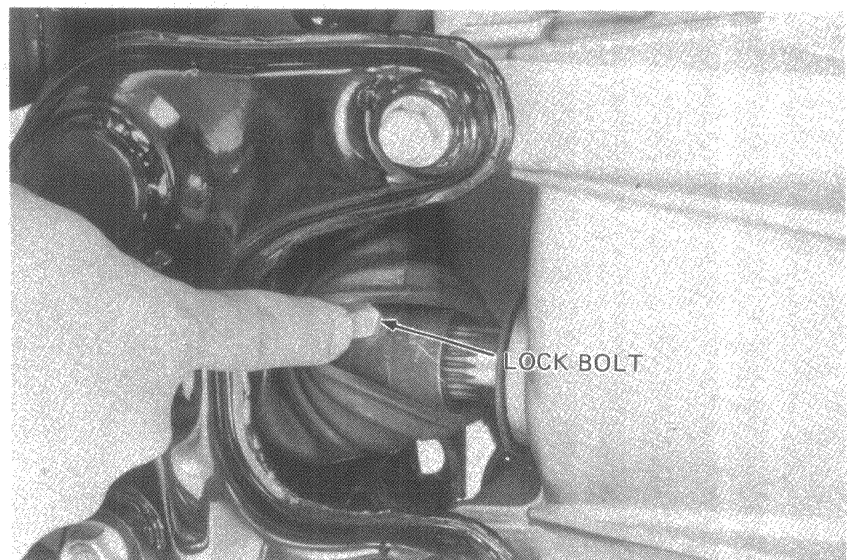



Place a jack under the engine to support its weight.
Remove the engine rear mounting bolts.

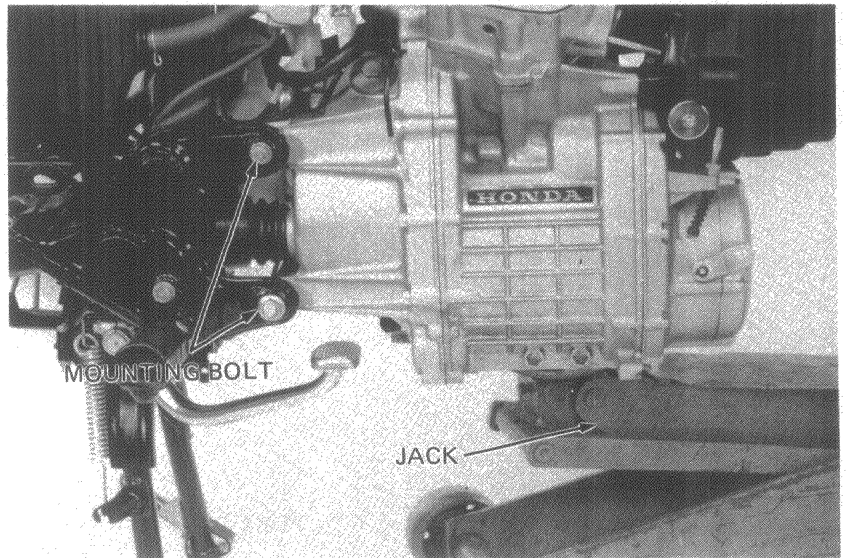

Remove the engine front hanger bolts.

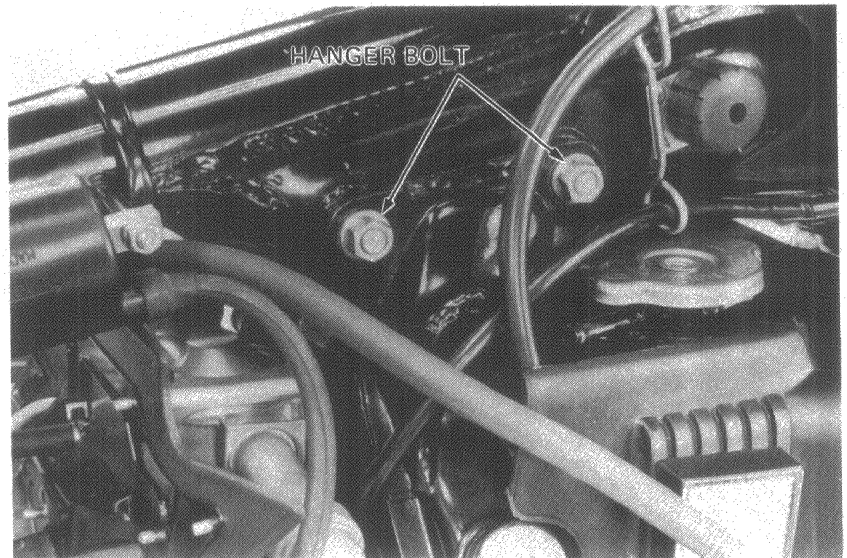

Disengage the final shaft from the U-joint assembly by adjusting the jack height and moving the engine forward.
Remove the engine from the frame.

CAUTION

Jack height must be continuously adjusted during engine removal and installation to prevent damage to mounting bolt threads, wire harnesses and cables.

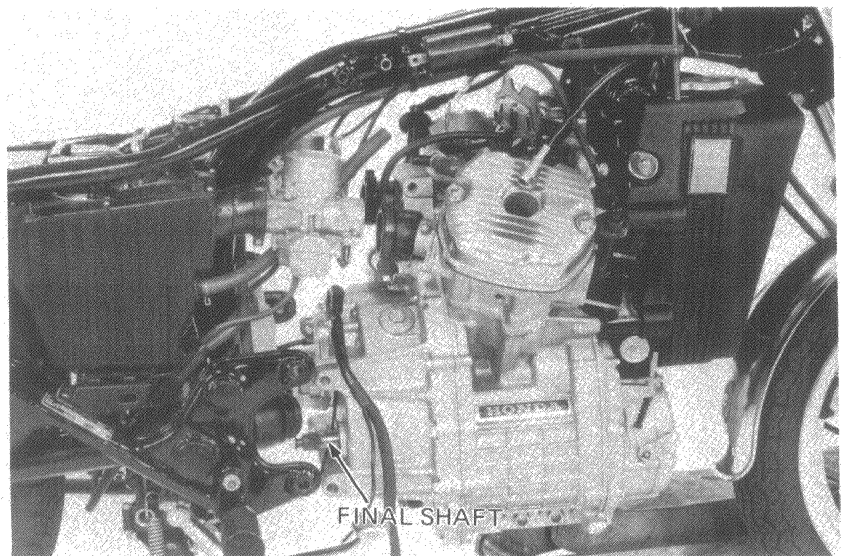



Disconnect the water pump bypass hose.
Remove the air spoiler.
Remove the grommets and 6 mm screws.
Remove the radiator cover.
Remove the radiator mounting bolts.

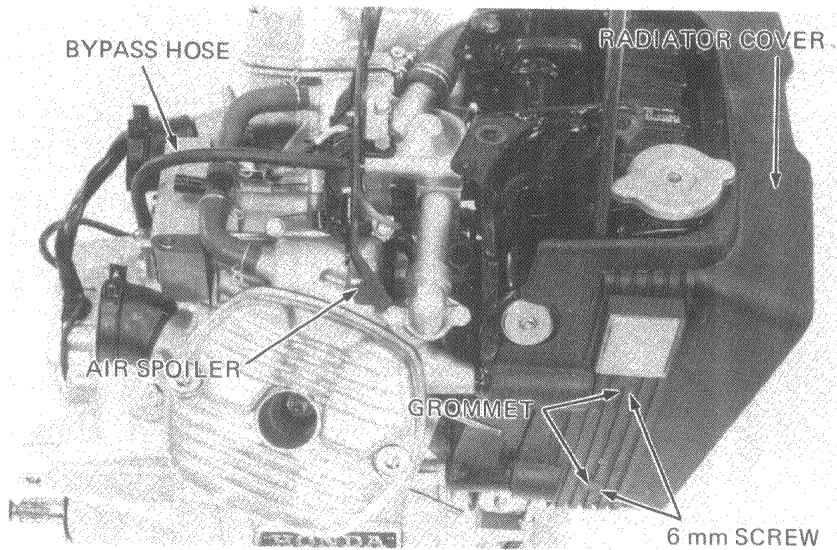

Loosen the radiator cap.
Remove the radiator drain bolt, and drain the coolant.
Loosen the radiator upper and lower hose bands.
Remove the radiator mount bolts.
Remove the radiator while pulling off the upper hose.

NOTE

Do not damage the radiator fins.

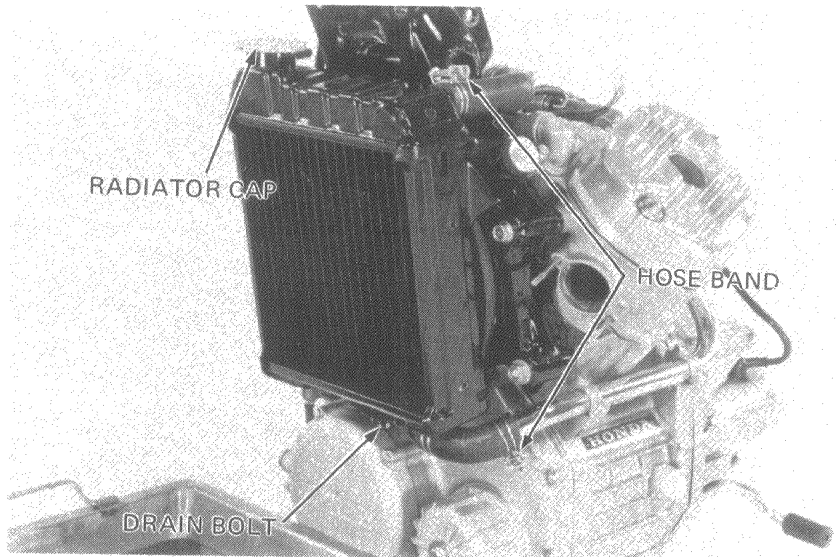

Remove the front engine hanger.
Remove the clutch wire.

NOTE

If the cylinder heads must be removed, remove the cylinder drain bolts, and drain the coolant.

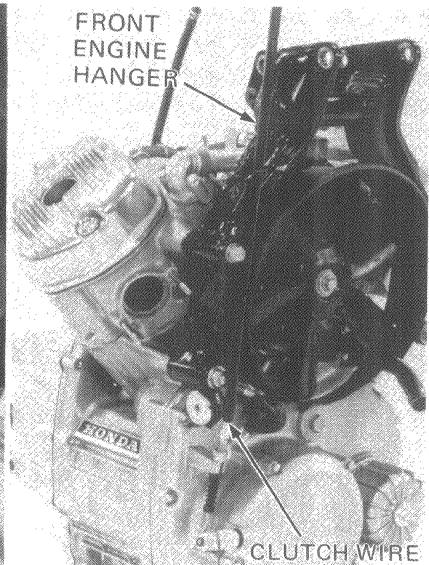
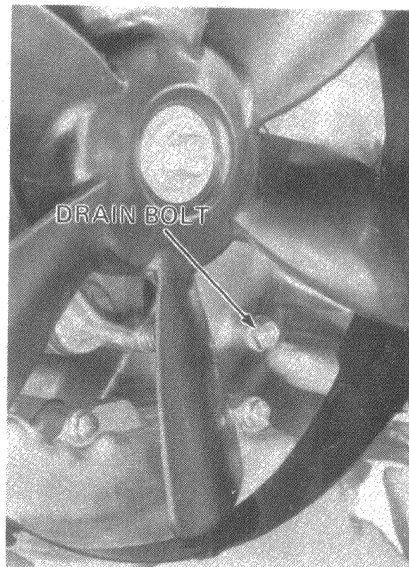



ENGINE INSTALLATION

The installation sequence is essentially the reverse of removal.

Place the transmission into gear.

Raise the engine with a jack and align the drive shaft with the final shaft.

Slide the drive shaft into the U-joint assembly by moving the engine backward.

NOTE

Make sure that the final shaft splines are exposed 5–6 mm from the end of the U-joint.

Torque the lock bolt securely.

**TORQUE VALUE: 1.8–2.5 kg-m
(13–18 ft-lbs)**

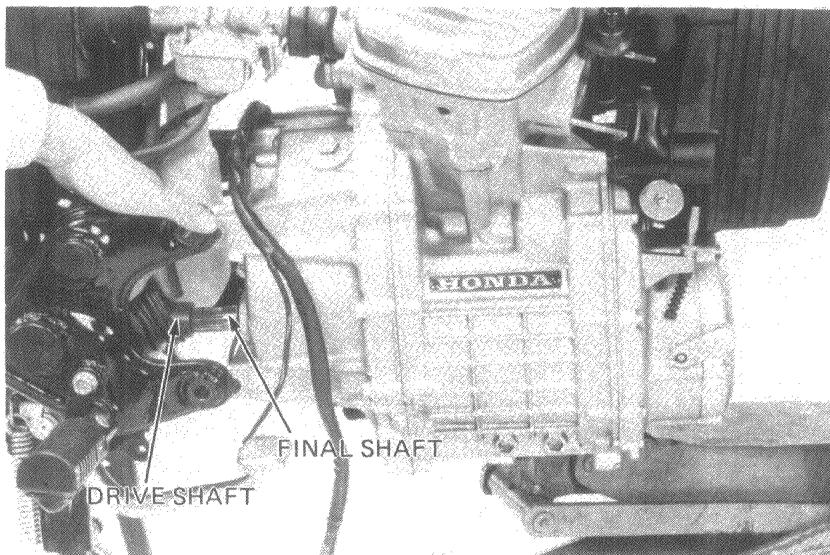

- Align the mounting surfaces carefully to prevent damage to mounting bolt threads, wire harnesses and cables.
- Route the wires and cables properly (Page 1-8).
- Fill the engine with the recommended oil.
- Perform the following adjustments:
Throttle cable free play (Page 3-5).
Clutch lever free play (Page 3-13).

WARNING

Insert the upper engine hanger bolts from the left. The bolts have rounded heads to prevent chafing of the main wire harness.

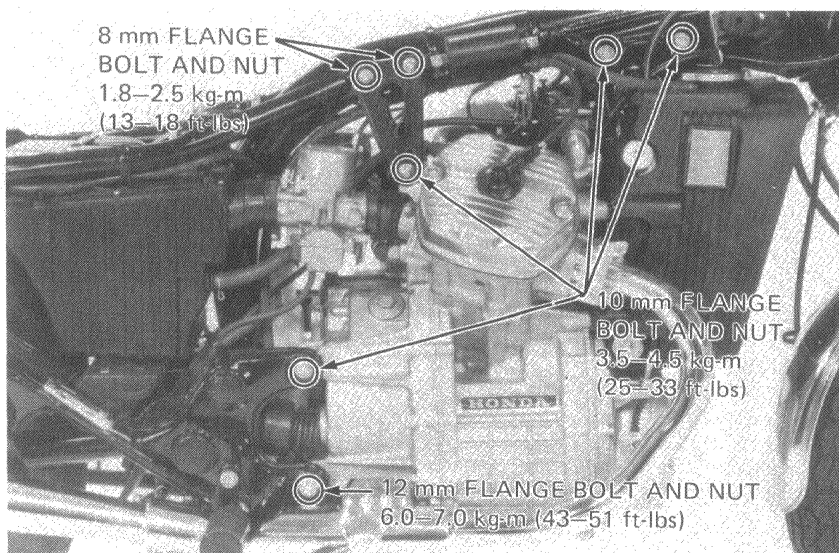

CYLINDER HEAD/VALVE



HONDA
CX500

