



SERVICE INFORMATION	11-1
TROUBLESHOOTING	11-2
GEARSHIFT LINKAGE REMOVAL	11-3
FINAL SHAFT DISASSEMBLY	11-3
FINAL SHAFT ASSEMBLY	11-4
TRANSMISSION DISASSEMBLY	11-4
TRANSMISSION ASSEMBLY	11-10
GEARSHIFT LINKAGE INSTALLATION	11-13

SERVICE INFORMATION

• WORKING PRACTICE

Before reassembling, lubricate the M4 and M5 gears with molybdenum disulfide grease (MOLYCOAT 321) or an equivalent. Apply engine oil to the other gears.

• SPECIAL TOOLS

Special tools

CRANK CAP DRIVER (for damper spring compressor)	07945-4150100
BEARING REMOVER (20 mm)	07936-3710600
BEARING REMOVER HANDLE	07936-3710100
BEARING REMOVER WEIGHT	07936-3710200
BEARING DRIVER ATTACHMENT	07945-3330100
BEARING DRIVER HANDLE	07949-6110000
BEARING DRIVER ATTACHMENT	07946-3600000
BEARING DRIVER ATTACHMENT	07946-3710200
BEARING DRIVER HANDLE	07947-3710000
BALL RACE REMOVER/DRIVER	07946-3290200

Common tools

BEARING DRIVER (42 x 47 mm)	07746-0010300
BEARING DRIVER PILOT (20 mm)	07746-0040500
BEARING DRIVER HANDLE (A)	07749-0010000
BEARING DRIVER (52 x 55 mm)	07746-0010400
BEARING DRIVER PILOT (25 mm)	07746-0040600

**TRANSMISSION**● **SPECIFICATIONS**

Unit: mm (in.)

Item		Standard		Service Limit		
Transmission	M2, M3, M4 and M5 gear I.D.	25.020–25.041	(0.9850–0.9859)	25.10	(0.988)	
	C1 gear I.D.	24.020–24.041	(0.9457–0.9465)	24.10	(0.949)	
	C2 gear I.D.	27.520–27.541	(1.0835–1.0843)	27.60	(1.087)	
	C3 and C4 gear I.D.	25.020–25.041	(0.9850–0.9859)	25.10	(0.988)	
	C5 gear I.D.	32.000–32.025	(1.2598–1.2608)	32.10	(1.264)	
	C1 gear bushing	I.D.	20.020–20.041	(0.7882–0.7890)	20.06	(0.790)
		O.D.	23.984–24.005	(0.9443–0.9451)	23.95	(0.943)
	Mainshaft O.D.	24.940–24.959	(0.9819–0.9827)	24.91	(0.781)	
	Countershaft O.D.	At C1	19.987–20.000	(0.7869–0.7874)	19.96	(0.786)
		At C2	27.459–27.480	(1.0811–1.0818)	27.43	(1.080)
		At C3 and C4	24.959–24.980	(0.9826–0.9835)	24.93	(0.981)
At C5		31.950–31.975	(1.2579–1.2586)	31.91	(1.256)	
Gear-to-bushing clearance		—		0.15	(0.006)	
Shift drum	O.D.	34.950–34.975	(1.3760–1.3770)	34.90	(1.374)	
	I.D.	35.00–35.025	(1.3780–1.3789)	35.06	(1.380)	
Shift fork	Claw thickness	5.930–6.000	(0.233–0.236)	5.50	(0.217)	
	I.D.	13.000–13.018	(0.5118–0.5125)	13.05	(0.514)	
Fork shaft	O.D.	12.966–12.984	(0.5105–0.5112)	12.95	(0.510)	
Final shaft spring	Free length	73.0	(2.8740)	68.0	(2.677)	

TROUBLESHOOTING**Hard to Shift**

- Improper clutch adjustment: too much free play
- Shift forks bent
- Shift shaft bent
- Shift fork claw bent
- Shift drum cam grooves damaged
- Shift guide pin damaged

Transmission Jumps Out of Gear

- Gear dogs worn
- Shift shaft bent
- Shift drum stopper broken
- Shift forks bent



GEARSHIFT LINKAGE REMOVAL

Remove the transmission cover (Page 7-8).
Remove the rear cover (page 9-6).
Remove the rear final shaft.
Remove the gearshift spindle and shift spring.
Remove the gearshift arm.

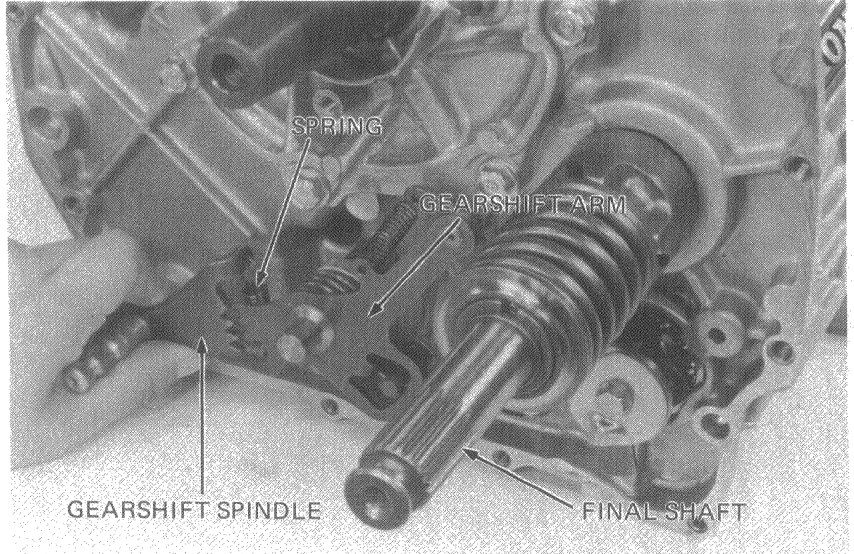

Remove the shift drum stopper spring.
Remove the shift drum stopper.
Remove the neutral switch plate, shift drum stopper plate, gearshift drum pin, and collar.

NOTE

Do not disassemble the shift drum plates and pin except when replacement is necessary.

Check all removed parts for wear or damage.

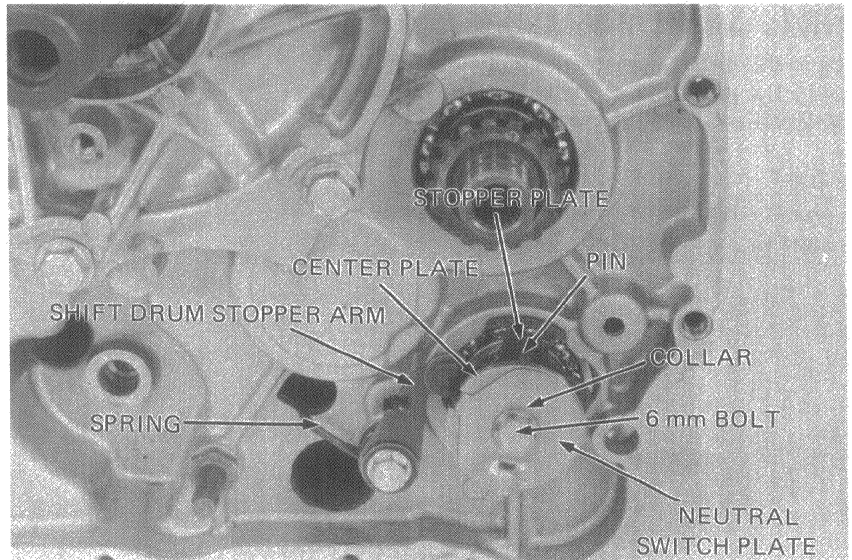

FINAL SHAFT DISASSEMBLY

Compress the spring with a press and CRANK CAP DRIVER and remove the spring cotters.
Remove the spring retainer, damper lifter and cam from the shaft.

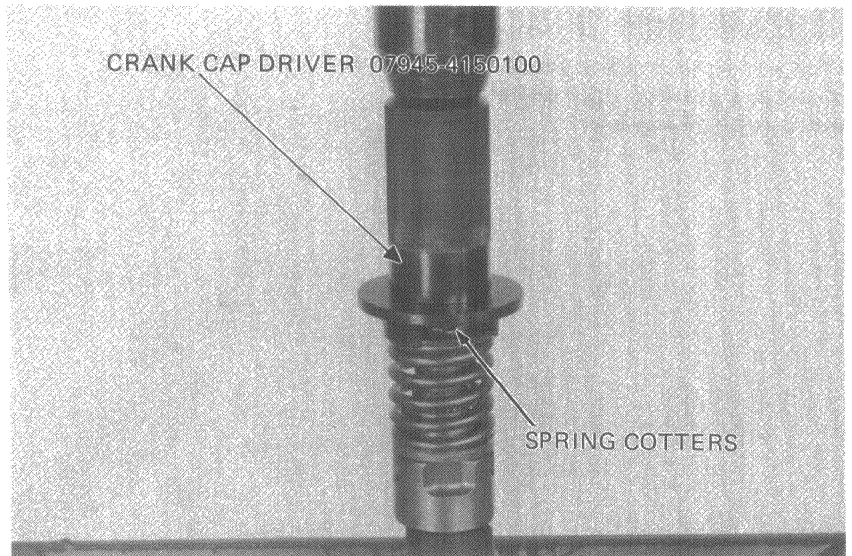



TRANSMISSION

Measure the damper spring free length.
Inspect the damper lifter, shaft, and retainer for wear or damage.

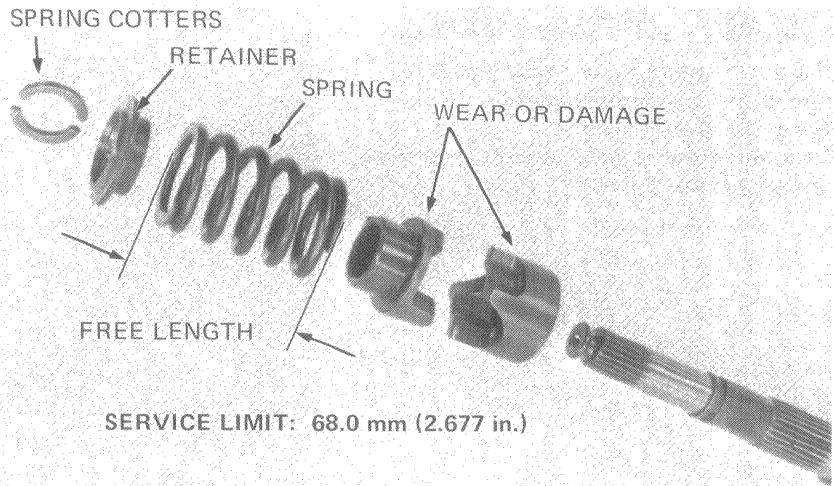

FINAL SHAFT ASSEMBLY

Slide the lifter, spring and retainer over the shaft. Compress the spring in the CRANK CAP DRIVER and install the spring cotters.

NOTE

Make sure that the cotters are properly seated.

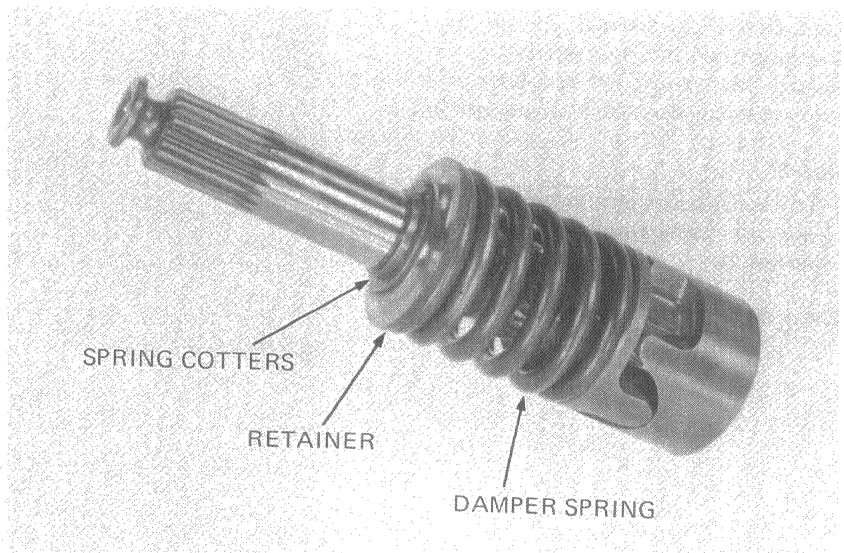

TRANSMISSION DISASSEMBLY

Remove the transmission cover and remove the clutch as an assembly (See section 7).
Remove the oil separator.

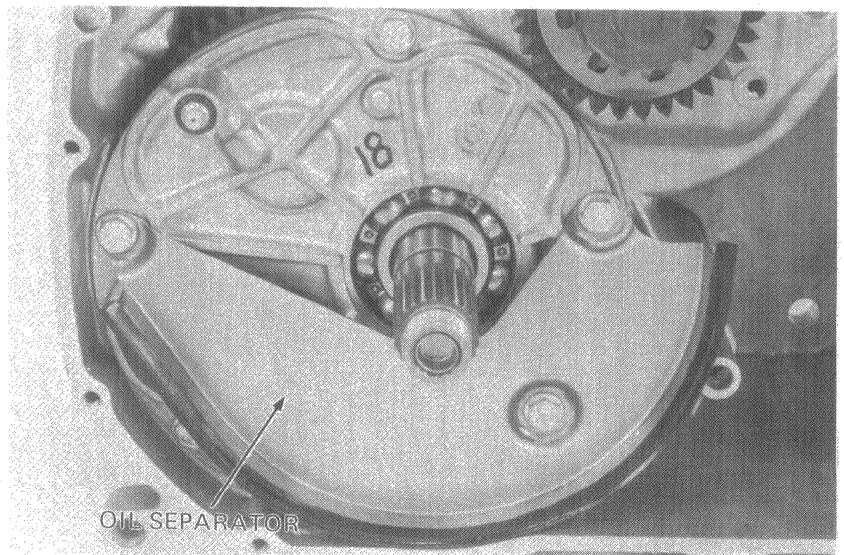



Remove the transmission holder bolts.

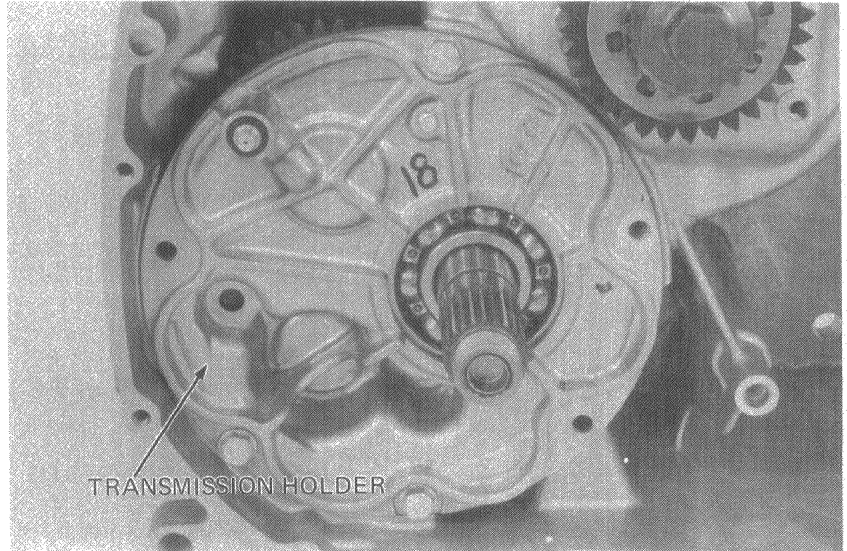

Drive the ends of the countershaft and shift drum carefully and evenly with a soft hammer until the transmission holder is clear of the engine case.

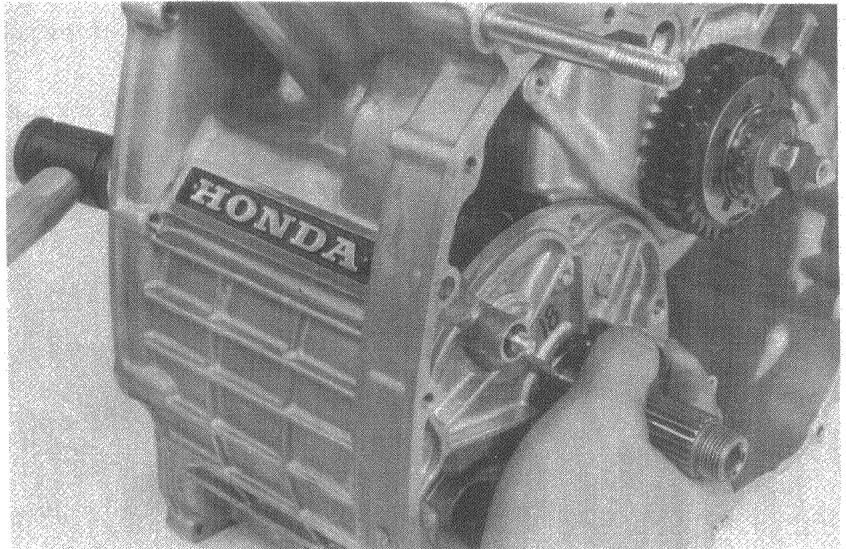

Remove the transmission as shown.

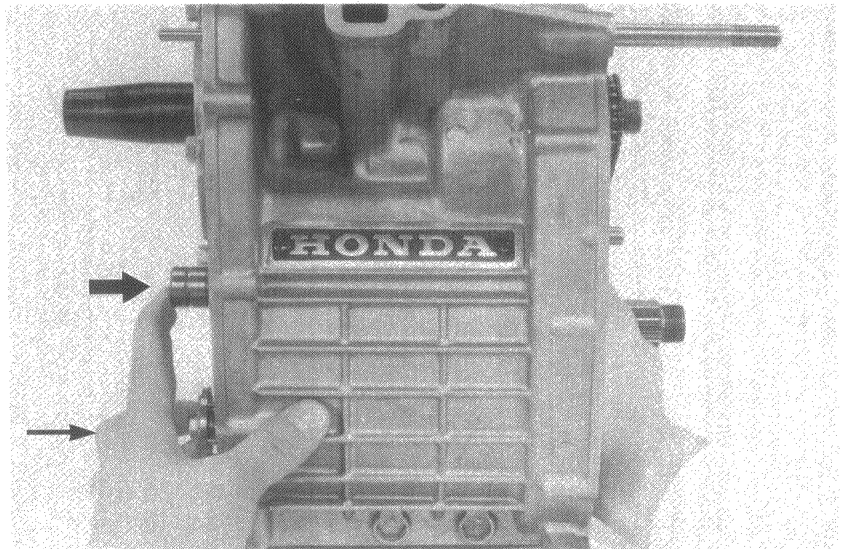

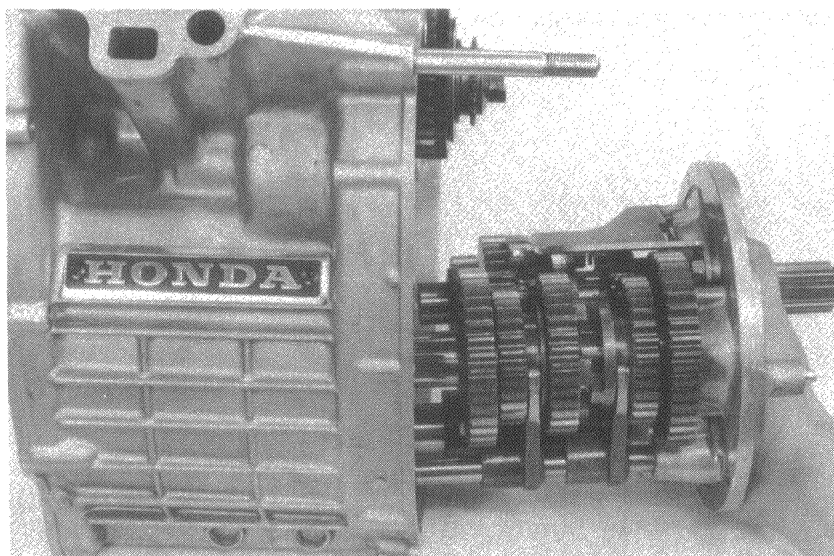

Remove the shift fork shafts.
Remove the shift forks and the guide pins.
Remove the shift drum.

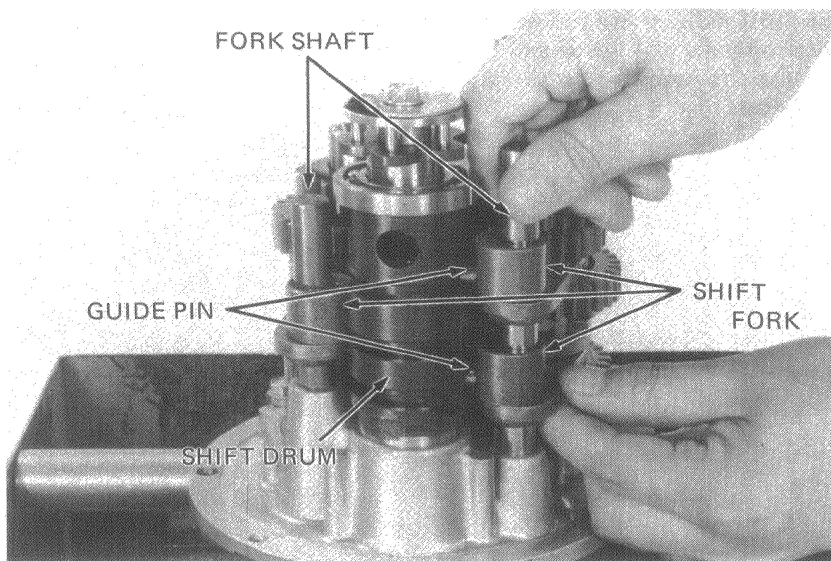

Remove 2nd and 5th gears from the counter-shaft and mainshaft.

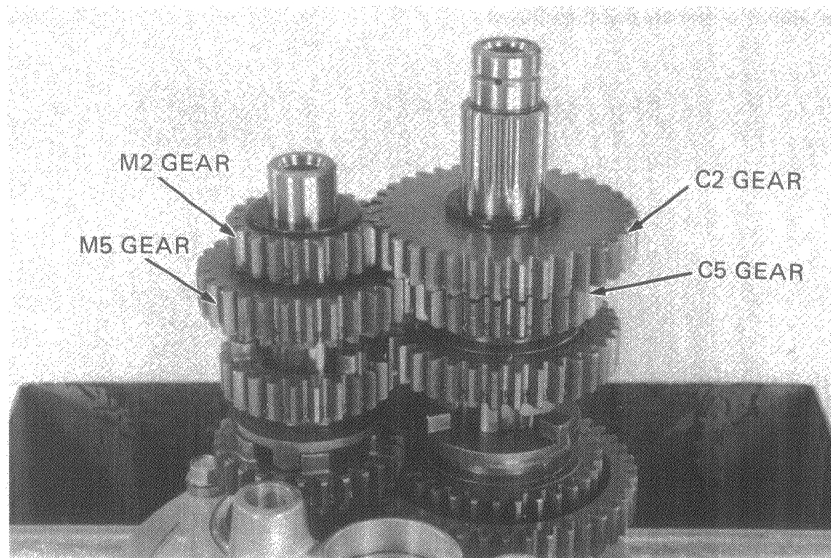



Disassemble the countershaft.

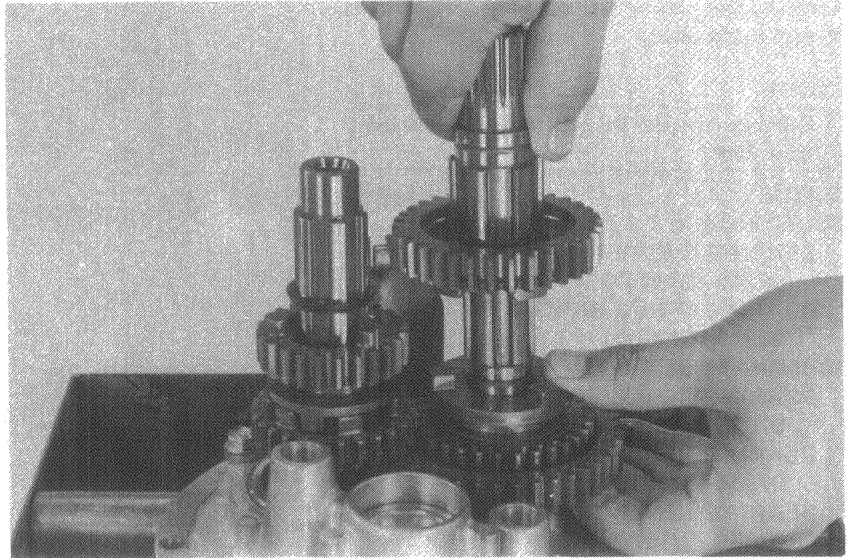

Remove the mainshaft, lightly tapping the end of it with a soft hammer.
Remove the gears by prying off the snap ring.

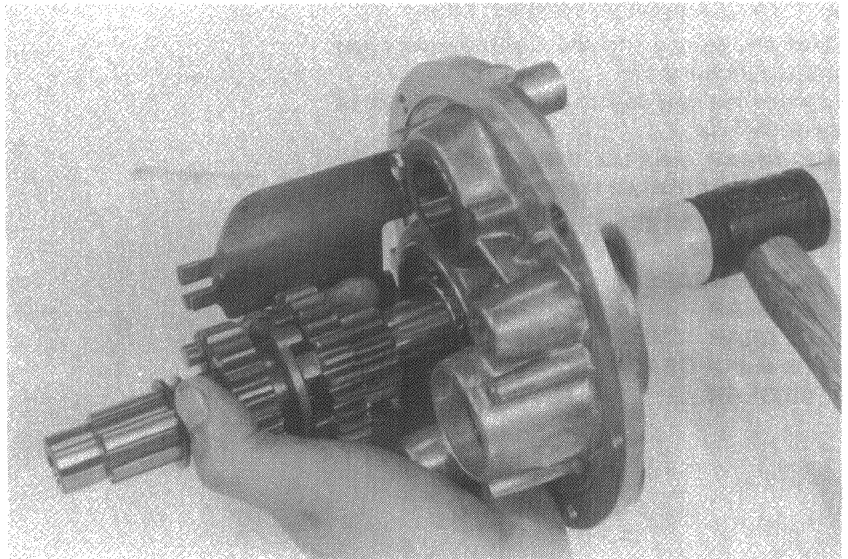

Inspect each holder bearing for wear or damage. They should rotate smoothly and be free of play or rattle.
Remove the bearings from the transmission holder.

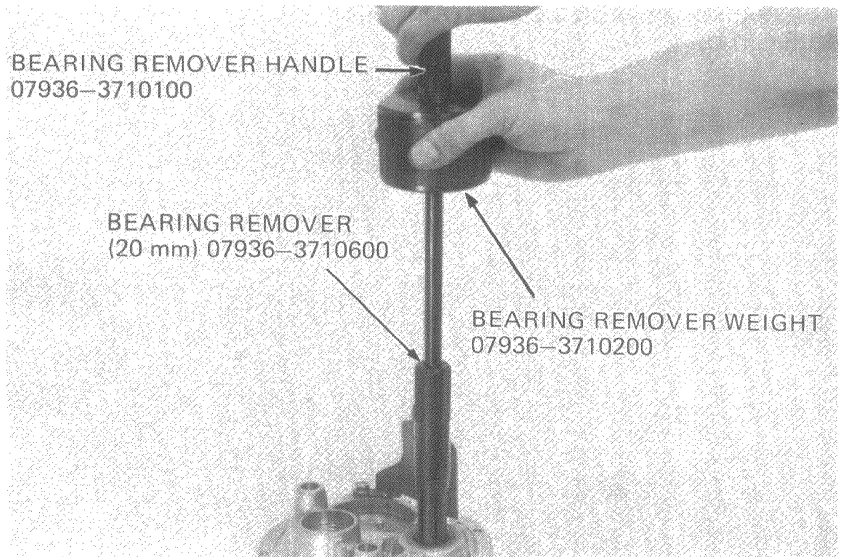



TRANSMISSION

Remove the mainshaft, countershaft bearings and oil guide plate.

NOTE

Bearings should be replaced if removed from case.

TOOLS

- COUNTERSHAFT BEARING BEARING DRIVER ATTACHMENT
07945-3330100
- BEARING DRIVE HANDLE
07949-6110000

- MAINSHAFT BEARING BEARING REMOVER (20 mm)
07936-3710600
- BEARING REMOVER HANDLE
07936-3710100
- BEARING REMOVER WEIGHT
07936-3710200

• **TRANSMISSION INSPECTION**

Check the gears for freedom of movement and rotation on the shaft.
Examine the gear dogs and slots for evidence of abnormal wear.
Measure each gear's I.D. If any gear exceeds the limit, the gear must be replaced.

SERVICE LIMITS:

M2, M3, M4 and M5 GEARS	:25.10 mm (0.988 in.)
C1 GEAR	:24.10 mm (0.949 in.)
C2 GEAR	:27.60 mm (1.087 in.)
C3 and C4 GEARS	:25.10 mm (0.988 in.)
C5 GEAR	:32.10 mm (1.264 in.)

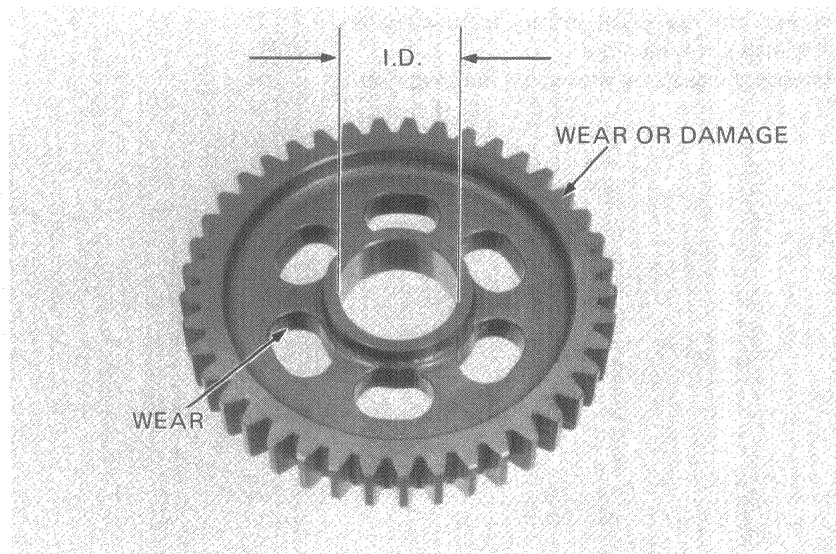
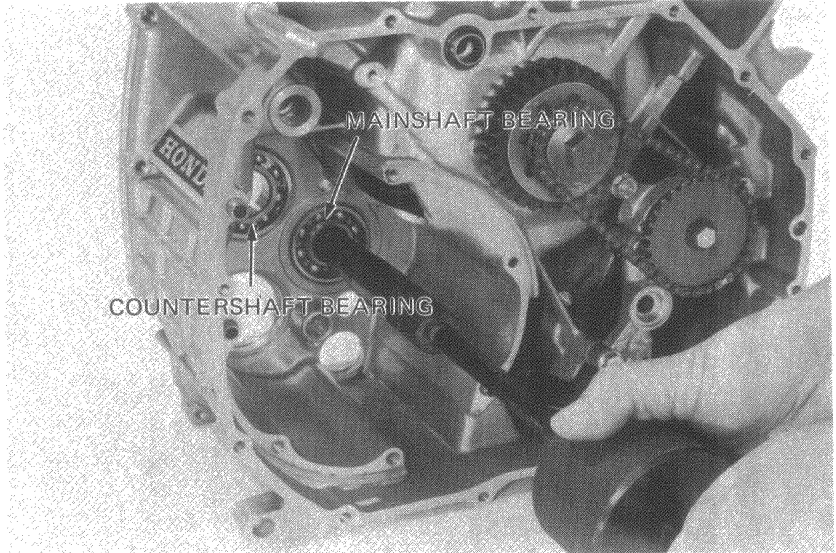

Measure the countershaft low gear (C1) bushing I.D. and O.D.

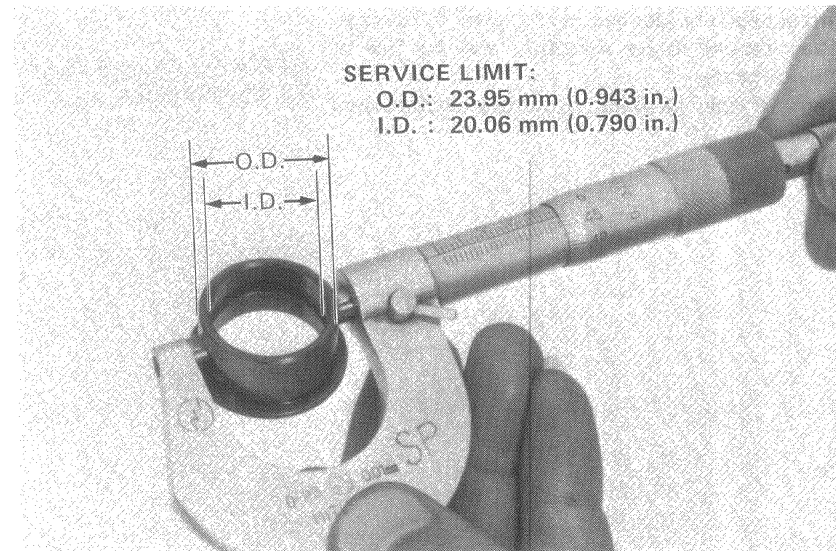



Measure and record the O.D. of the mainshaft and countershaft at the locations shown.

SERVICE LIMITS:

- A: 27.43 mm (1.080 in.)**
- B: 31.91 mm (1.256 in.)**
- C: 24.93 mm (0.982 in.)**
- D: 19.96 mm (0.786 in.)**
- E: 24.91 mm (0.781 in.)**
- F: 24.91 mm (0.781 in.)**

Calculate the clearance between the gear and gear shaft or bushing

SERVICE LIMIT: 0.15 mm (0.0059 in.)

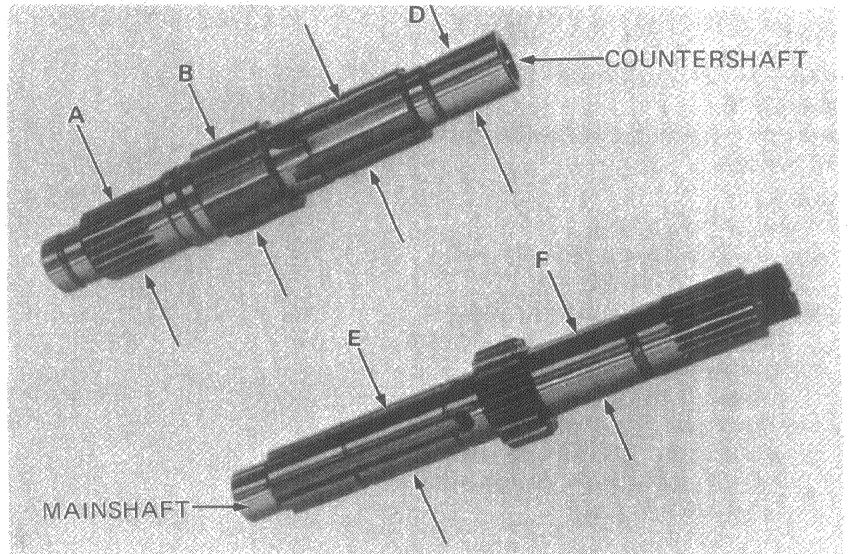

Measure the shift fork I.D. and claw thickness. Measure the shift fork shaft O.D.

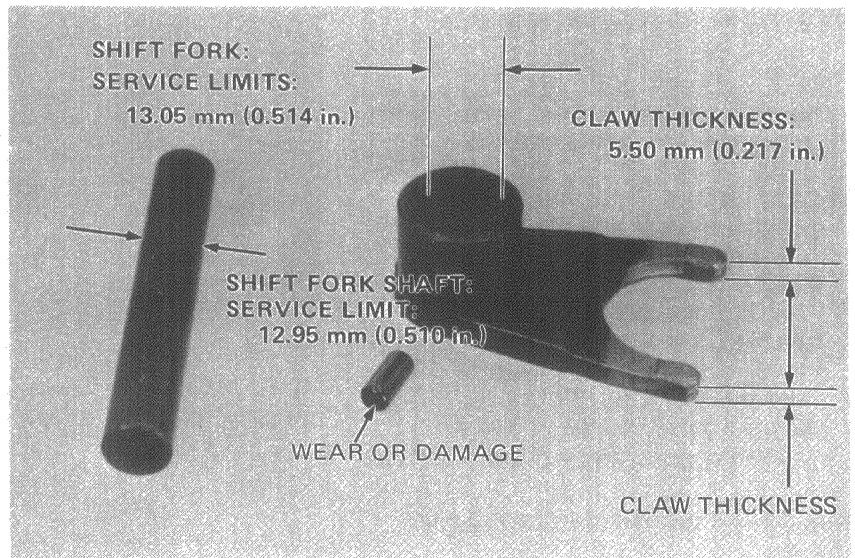

Measure the transmission holder I.D. Inspect each holder bearing for wear or damage. Spin the bearing by hand. Bearings must be replaced if they are noisy or have excessive play.

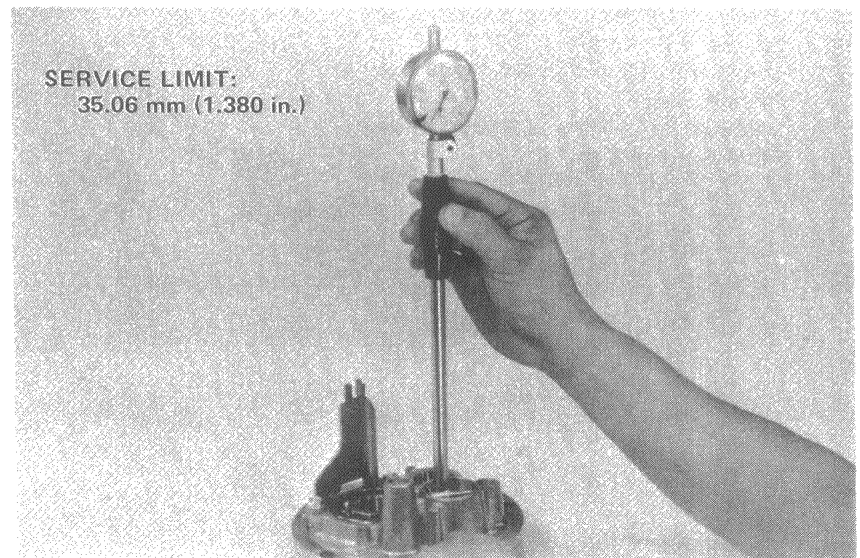



TRANSMISSION

TRANSMISSION ASSEMBLY

Install the oil guide plate in the mainshaft bearing hole.

Install the mainshaft and countershaft bearings into the case.

TOOLS

MAINSHAFT BEARING

- BEARING DRIVER (42 x 47 mm)
- BEARING PILOT (20 mm)
- BEARING DRIVER ATTACHMENT
07946-3710200
- BEARING DRIVER HANDLE
07949-3710000

COUNTERSHAFT BEARING

- BEARING DRIVER (52 x 55 mm)
- BEARING DRIVER PILOT (25 mm)
- DRIVER HANDLE (A)

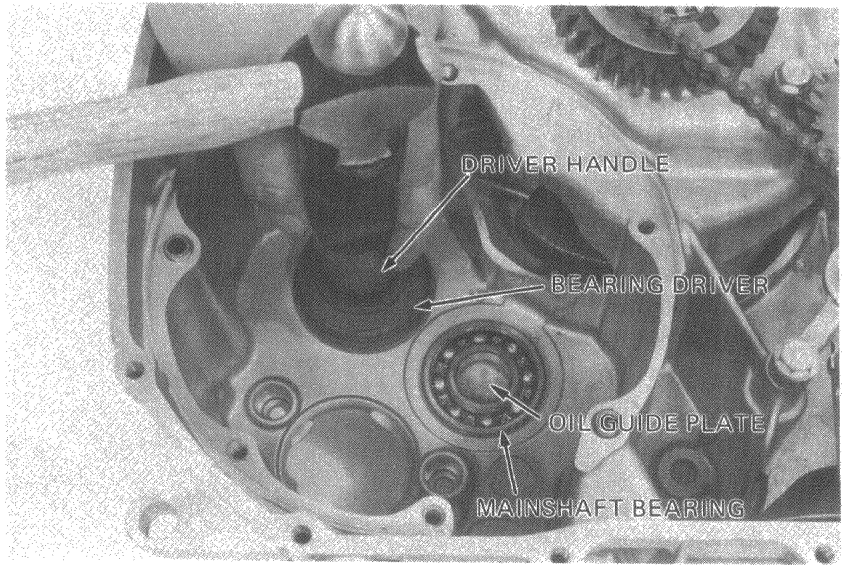

Install the transmission holder bearing.

NOTE

Support the transmission holder above the workbench to prevent damaging it.

TOOLS

- DRIVER HANDLE (A)
07949-0010000
- BEARING DRIVER ATTACHMENT
07946-3600000
- BEARING DRIVER PILOT (25 mm)
- BEARING DRIVER HANDLE

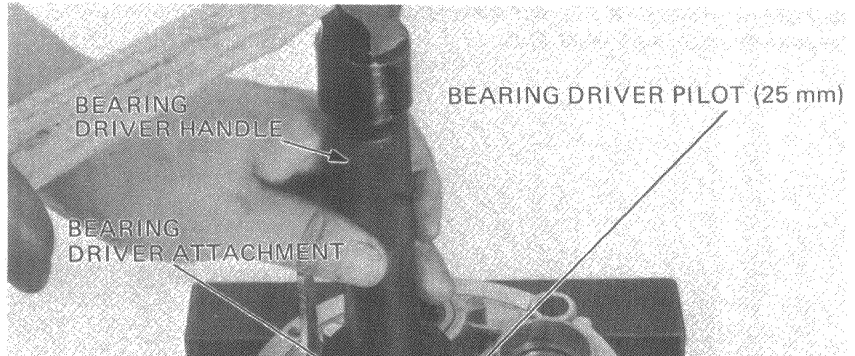



Insert the mainshaft, assembly into the holder bearing until it seats lightly.

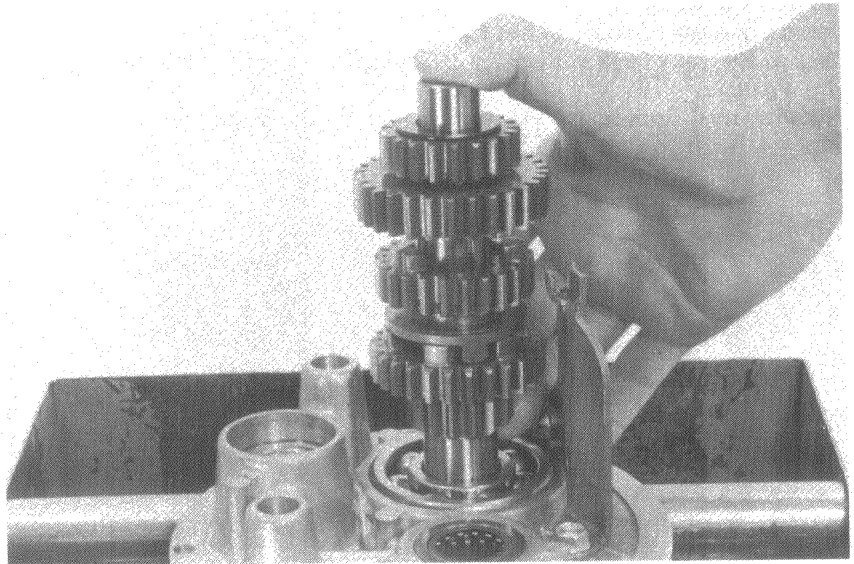

Insert the countershaft assembly into the bearing holder.
Check the engagement of the gears on the countershaft and mainshaft.

NOTE

During installation, hold the thrust washer to prevent it from falling.

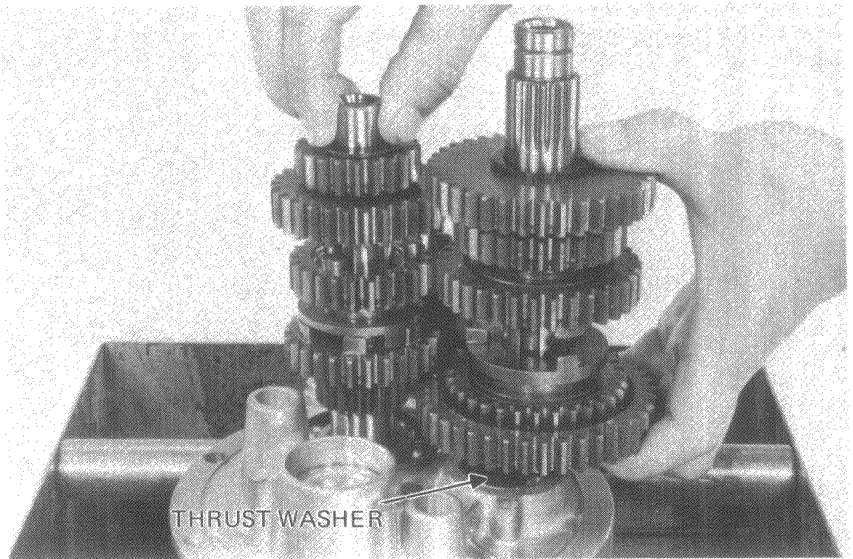

Press the gear assembly into position by lightly tapping the mainshaft with a soft hammer.

NOTE

Hold the countershaft low gear to prevent it from coming off.

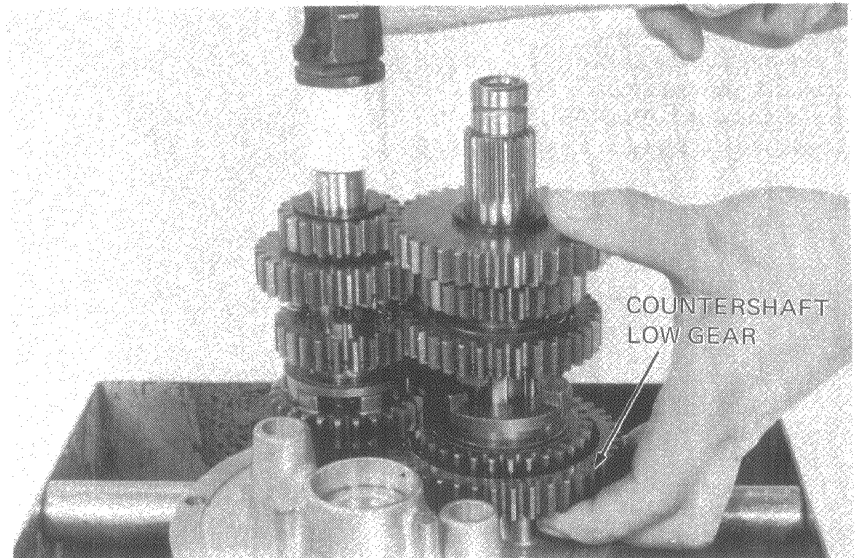



TRANSMISSION

Install the shift drum.
Insert a guide pin into each shift fork.
Engage the shift forks with the gears and shift drum groove.
Install the shift fork shafts.

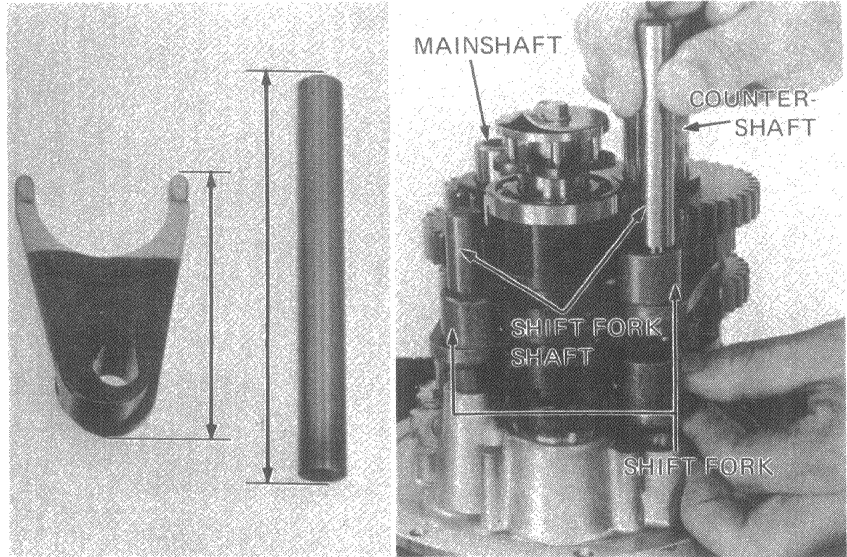

Place the transmission in neutral.
Insert the transmission assembly into the engine case.

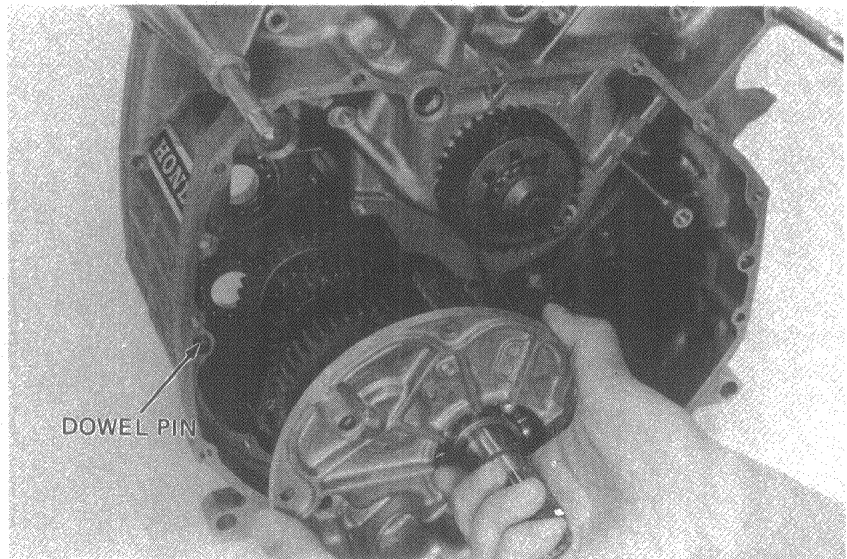

Press the transmission holder into place while rotating the mainshaft.
Torque the holder bolts.
Install the oil separator.
Install the clutch (Page 7-6).
Install the transmission cover (Page 7-13).

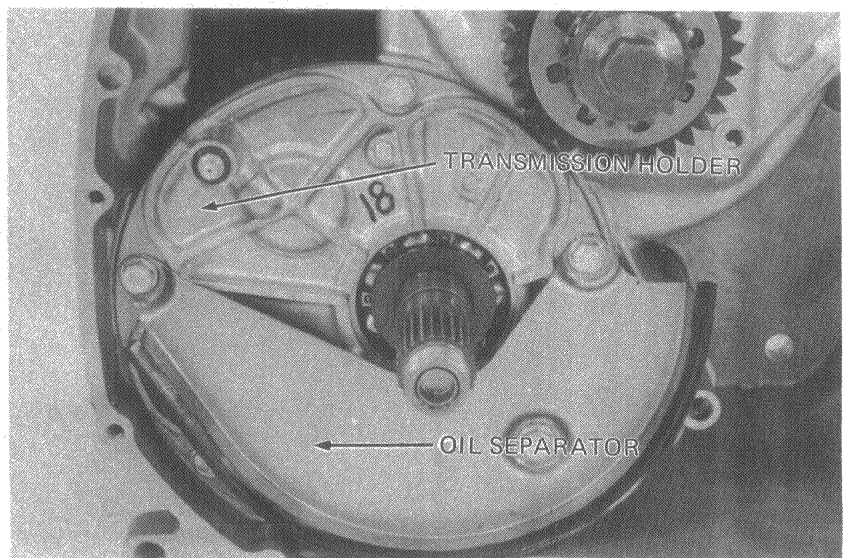



GEARSHIFT LINKAGE INSTALLATION

Install the shift drum cam plate, pin, collar, center plate, and point plate.

Install the gearshift arm.

Install the spring on the shift arm and shift spindle.

Install the spindle.

Rotate the shift drum to neutral.

Install the drum stopper cam plate.

Apply a locking agent and tighten the 6 mm bolt.

Attach the stopper spring hook onto the case.

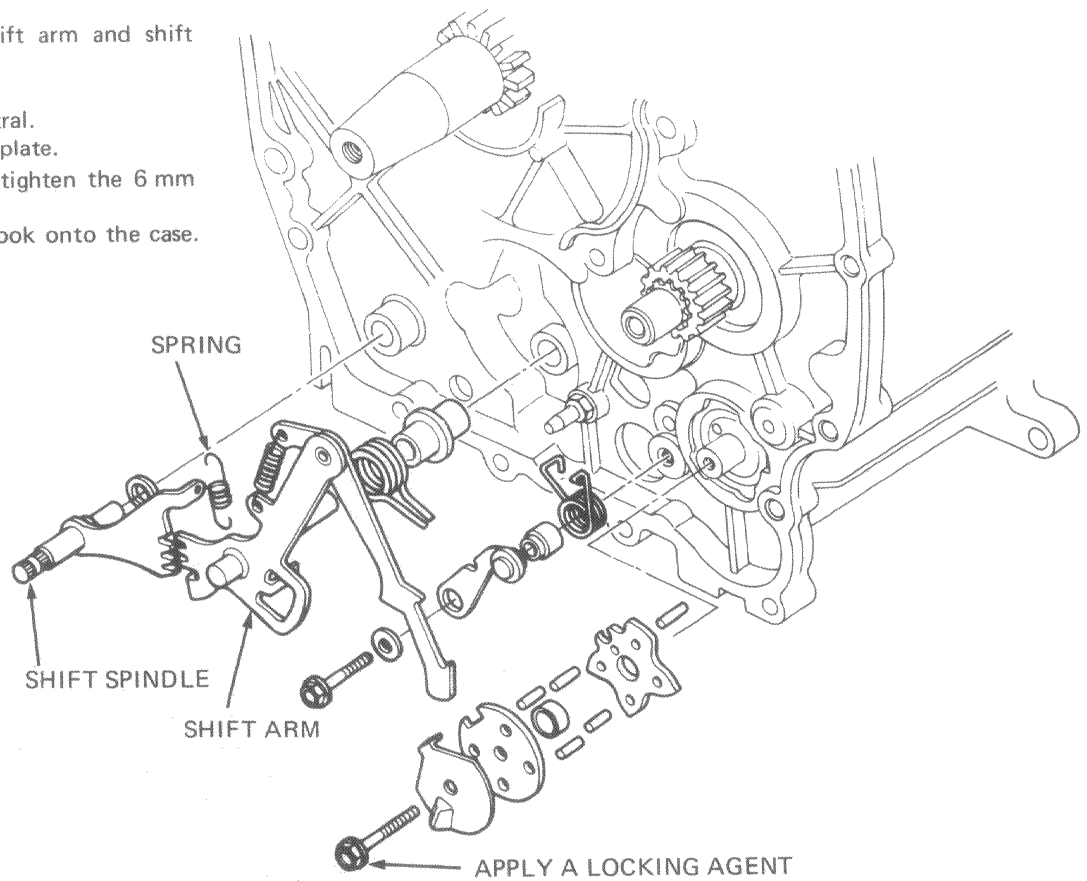

Install the final shaft.

Install the rear cover (See section 9).

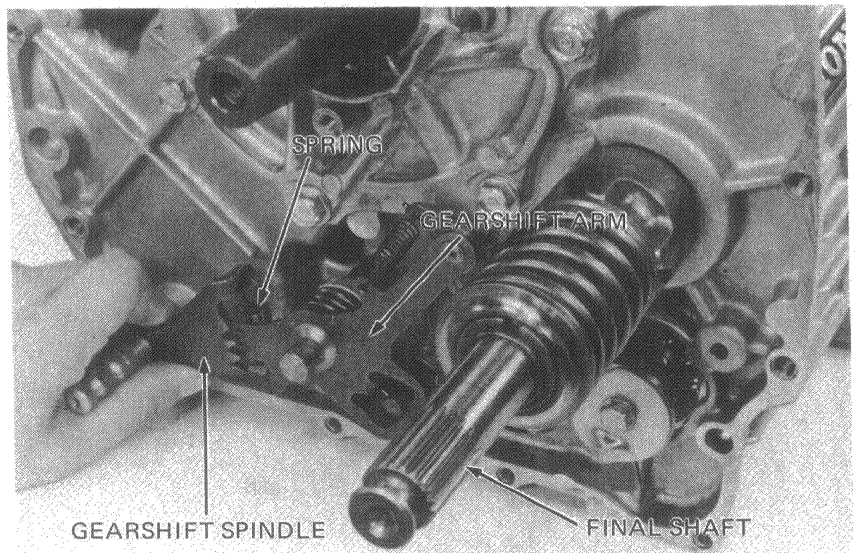

TRANSMISSION



HONDA
CX500

