



INTRODUCTION

This addendum contains service information for the 1982 CX500 Custom. Refer to the base shop manual and previous addendums for service information not included in this addendum.

ALL INFORMATION, ILLUSTRATIONS, DIRECTIONS AND SPECIFICATIONS INCLUDED IN THIS PUBLICATION ARE BASED ON THE LATEST PRODUCT INFORMATION AVAILABLE AT THE TIME OF APPROVAL FOR PRINTING. HONDA MOTOR CO., LTD. RESERVES THE RIGHT TO MAKE CHANGES AT ANY TIME WITHOUT NOTICE AND WITHOUT INCURRING ANY OBLIGATION WHATEVER. NO PART OF THIS PUBLICATION MAY BE REPRODUCED WITHOUT WRITTEN PERMISSION.

HONDA MOTOR CO., LTD.
Service Publications Office

TABLE OF CONTENTS

1. GENERAL INFORMATION	25-2
SPECIFICATIONS	25-2
MAINTENANCE SCHEDULE	25-3
CABLE AND HARNESS ROUTING	25-4
2. LUBRICATION	25-5
3. INSPECTION AND ADJUSTMENT	25-5
FUEL VALVE STRAINER	25-5
BRAKE FLUID	25-6
BRAKE PAD WEAR	25-6
4. CARBURETOR	25-7
HIGH ALTITUDE ADJUSTMENT	25-7
5. AC GENERATOR/FLYWHEEL/ REAR COVER	25-8
ENGINE REAR COVER	25-8
IGNITION TIMING ADJUSTMENT	25-11
6. FRONT BRAKE	25-13
BRAKE PAD REPLACEMENT	25-13
BRAKE CALIPER	25-14
7. IGNITION SYSTEM	25-18
8. WIRING DIAGRAM	25-23



1. GENERAL INFORMATION

SPECIFICATIONS

New specifications for the 1982 CX500C are listed below. Refer to the base shop manual and previous addendums for other specifications.

ITEM		SPECIFICATION		
DIMENSIONS	Overall width	855 mm (33.7 in)		
	Overall height	1,195 mm (47.0 in)		
	Wheelbase	1,465 mm (57.7 in)		
	Seat height	790 mm (31.1 in)		
	Foot peg height	335 mm (13.2 in)		
FRAME	Cold tire pressures	Up to 90 kg (200 lbs) load	Front Rear	28 psi (2.0 kg/cm ²) 28 psi (2.0 kg/cm ²)
		Up to vehicle capacity load	Front Rear	28 psi (2.0 kg/cm ²) 32 psi (2.25 kg/cm ²)
	DRIVE TRAIN	Final reduction		3.091 (11/34)
		ELECTRICAL		Ignition Ignition timing "F" mark Full advance Generator
LIGHTS	Spark plug	Standard	DR8ES-L (NGK) or X24ESR-U (ND)	
		For extended high speed riding	DR8ES (NGK) or X27ESR-U (ND)	
LIGHTS	Speedometer light	3.4W (2 cp SAE No. 158)		
	Tachometer light	3.4W (2 cp SAE No. 158)		
	Neutral indicator	3.4W (2 cp SAE No. 158)		
	Turn signal indicator	3.4W (2 cp SAE No. 158)		
	High beam indicator	3.4W (2 cp SAE No. 158)		



MAINTENANCE SCHEDULE

Perform the PRE-RIDE INSPECTION in the Owner's Manual at each scheduled maintenance.

I: INSPECT AND CLEAN, ADJUST, LUBRICATE OR REPLACE IF NECESSARY

C: CLEAN

R: REPLACE

A: ADJUST

L: LUBRICATE

FREQUENCY	WHICHEVER COMES FIRST	ODOMETER READING [NOTE 3]								REFER TO PAGE
		EVERY	600 mi. (1,000 km)	4,000 mi. (6,400 km)	8,000 mi. (12,800 km)	12,000 mi. (19,200 km)	16,000 mi. (25,600 km)	20,000 mi. (32,000 km)	24,000 mi. (38,400 km)	
EMISSION RELATED ITEMS	* FUEL LINES				I		I		I	24-6
	* FUEL STRAINER		C	C	C	C	C	C	C	25-5
	* THROTTLE OPERATION		I		I		I		I	3-5
	* CARBURETOR-CHOKE				I		I		I	3-6
	AIR CLEANER	NOTE 1		C	R	C	R	C	R	3-2
	CRANKCASE BREATHER	NOTE 2		C	C	C	C	C	C	3-3
	SPARK PLUGS			R	R	R	R	R	R	23-6
	* VALVE CLEARANCE		I	I	I		I		I	3-4
	ENGINE OIL	YEAR	R		R		R		R	2-2, 25-5
	ENGINE OIL FILTER	YEAR	R		R		R		R	2-2
	* CAM CHAIN TENSION		A	A	A	A	A	A	A	3-5
	* CARBURETOR-SYNCHRONIZE		I		I		I		I	24-6
	* CARBURETOR-IDLING SPEED		I	I	I	I	I	I	I	3-6
	RADIATOR COOLANT						I		*R	3-8 9-3
	* RADIATOR CORE				I		I		I	3-8
* COOLING SYSTEM, HOSES & CONNECTIONS		I		I		I		I	3-8	
NON-EMISSION RELATED ITEMS	* DRIVE SHAFT JOINT				L		L		L	2-3
	FINAL DRIVE LUBRICANT				I		I		R	2-3
	BATTERY	MONTH	I	I	I	I	I	I	I	3-9
	BRAKE FLUID (FRONT)	MONTH I 2 YEARS *R	I	I	I	I	I	I	*R	25-6
	BRAKE SHOE/PAD WEAR			I	I	I	I	I	I	3-11, 25-6
	BRAKE SYSTEM		I		I		I		I	3-11
	* BRAKE LIGHT SWITCH		I		I		I		I	3-12
	* HEADLIGHT AIM		I		I		I		I	3-13
	CLUTCH		I	I	I	I	I	I	I	3-13
	SIDE STAND				I		I		I	3-14
	* SUSPENSION		I		I		I		I	3-14
* NUTS, BOLTS, FASTENERS		I		I		I		I	3-15	
** WHEELS		I		I		I		I	3-15	
** STEERING HEAD BEARING		I		I		I		I	3-15	

* SHOULD BE SERVICED BY AN AUTHORIZED HONDA DEALER, UNLESS THE OWNER HAS PROPER TOOLS AND SERVICE DATA AND IS MECHANICALLY QUALIFIED. REFER TO THE OFFICIAL HONDA SHOP MANUAL.

** IN THE INTEREST OF SAFETY, WE RECOMMEND THESE ITEMS BE SERVICED ONLY BY AN AUTHORIZED HONDA DEALER.

- NOTE:
1. Service more frequently when riding in dusty areas.
 2. Service more frequently when riding in rain or at full throttle.
 3. For higher odometer readings, repeat at the frequency interval established here.



CABLE AND HARNESS ROUTING

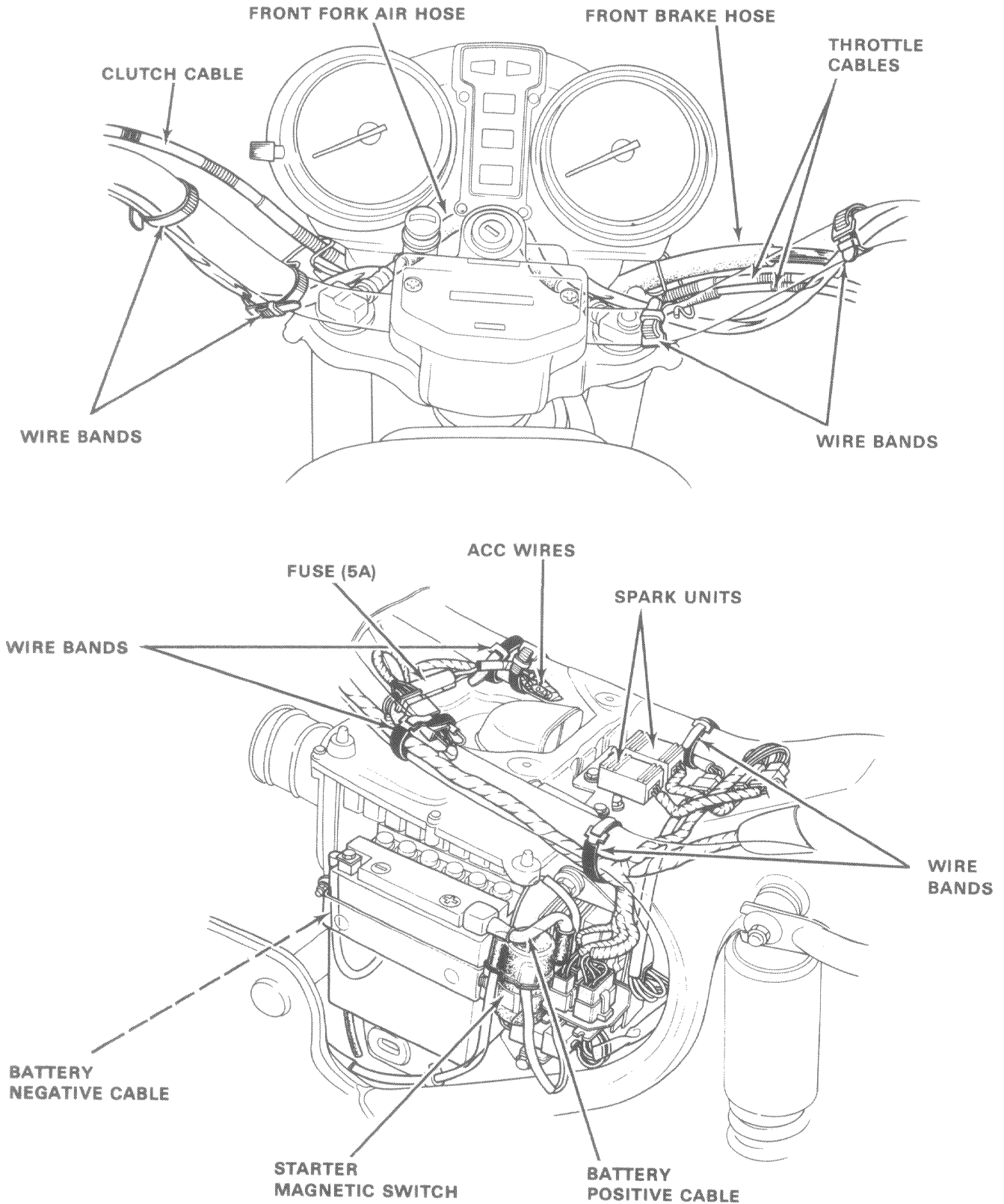



2. LUBRICATION

ENGINE OIL RECOMMENDATION

Use HONDA 4-STROKE OIL or equivalent
API SERVICE CLASSIFICATION: SE or SF
VISCOSITY: SAE 10W-40

Other viscosities shown in the chart may be used when the average temperature in your riding area is within the indicated range.

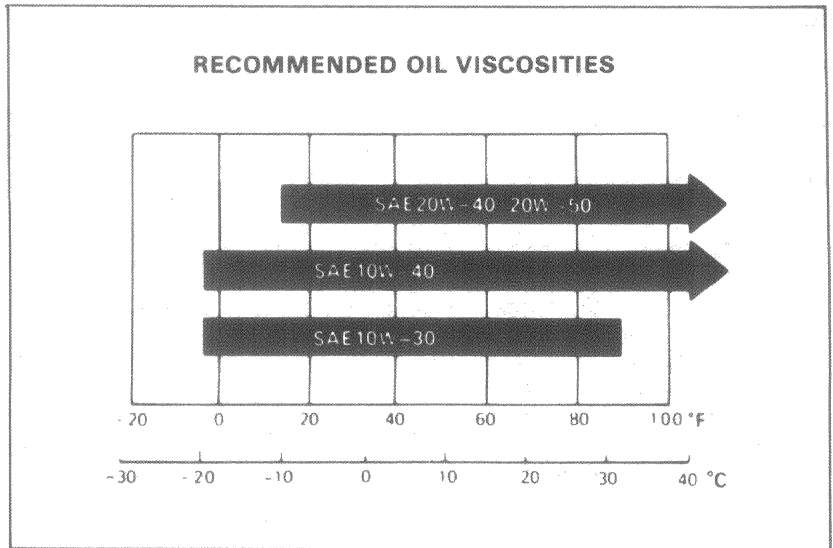

3. INSPECTION AND ADJUSTMENT

FUEL STRAINER

Turn the fuel valve OFF.

Remove the fuel cup, O-ring and filter screen, draining the gasoline into a suitable container.

WARNING

Gasoline is flammable and is explosive under certain conditions. Do not smoke or allow flames or sparks near the equipment while draining fuel.

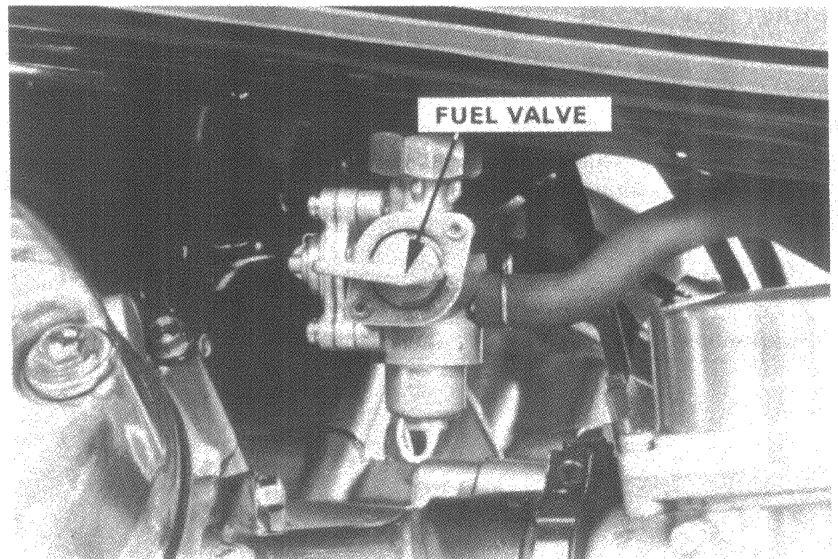

Wash the cup and filter screen in clean non-flammable or high flash point solvent. Reinstall the screen securely, aligning the index marks on the fuel valve body and filter screen.

Install a new O-ring into the fuel valve body. Reinstall the fuel cup, making sure the new O-ring is in place. Hand tighten the fuel cup and then torque it to specification.

TORQUE: 0.3-0.5 kg-m (2-4 ft-lb)

After installing, turn the fuel valve ON and check that there are no fuel leaks.

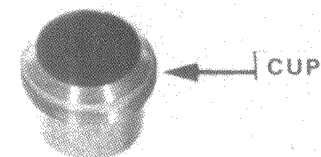
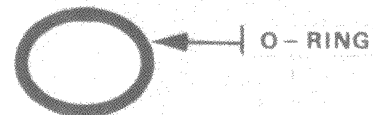



BRAKE FLUID

Check the front brake fluid reservoir level. If the level nears the lower level mark, fill the reservoir with DOT-3 BRAKE FLUID to the upper level mark. Check the entire system for leaks if the level is low.

CAUTION

- Do not remove the cover until the handlebar has been turned so that the reservoir is level.
- Avoid operating the brake lever with the cap removed. Brake fluid will squirt out if the lever is pulled.
- Do not mix different types of fluid, as they are not compatible.

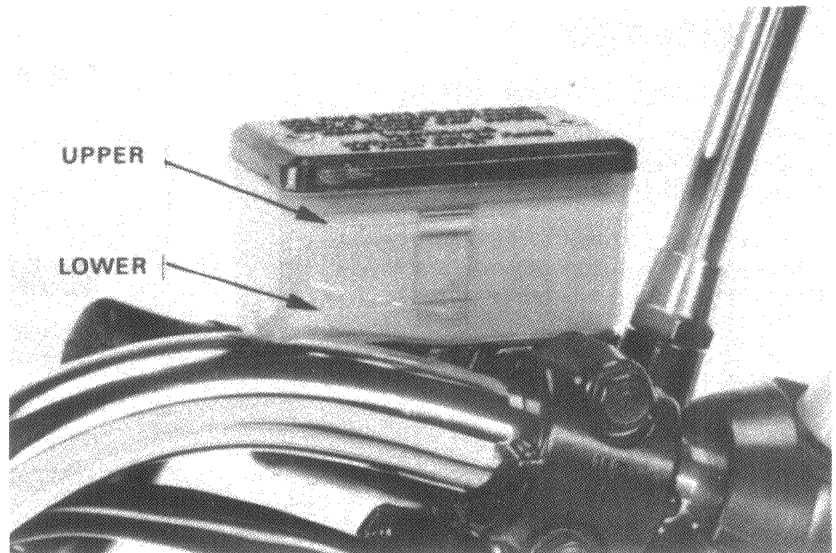

BRAKE PAD WEAR

Check the brake pads for wear by looking through the slot indicated by the raised arrow cast on the caliper assembly.

Replace the brake pads if the wear line on the pads reaches the edge of the brake disc (refer to page 25-13).

CAUTION

Always replace the brake pads in pairs to assure even disc pressure.

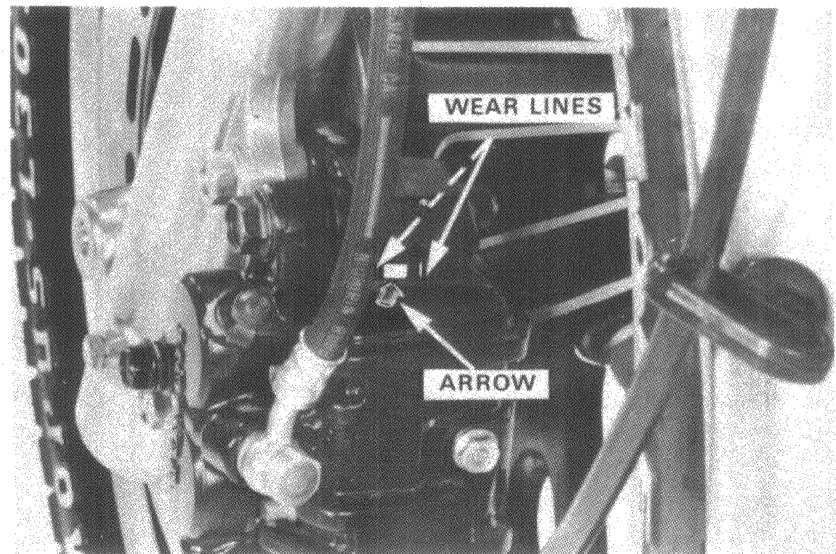



4. CARBURETOR

HIGH ALTITUDE ADJUSTMENT (U.S.A. ONLY)

When the vehicle is to be operated continuously above 6,500 feet (2,000 meters), the carburetors must be readjusted as described below to improve driveability and decrease exhaust emissions.

Warm up the engine to operating temperature. Stop and go driving for 10 minutes is sufficient.

Turn each pilot screw clockwise 1/2 turn.

Adjust the idle speed to $1,100 \pm 100$ rpm with the throttle stop screw.

NOTE

These adjustments must be made at high altitude to ensure proper high altitude operation.

Attach the Vehicle Emission Control Information Update label as shown.

NOTE

- Instructions for obtaining Vehicle Emission Control Update labels are given in Service Newsletter No. 132.
- Do not attach the label to any part that can be easily removed from the vehicle.

CAUTION

Operation at an altitude lower than 5,000 feet (1,500 meters) with the carburetors adjusted for high altitudes may cause the engine to idle roughly and stall.

When the vehicle is to be operated continuously below 5,000 feet (1,500 meters); turn each pilot screw counterclockwise to its original position against its stop and adjust the idle speed to $1,100 \pm 100$ rpm. Be sure to do these adjustments at low altitude.

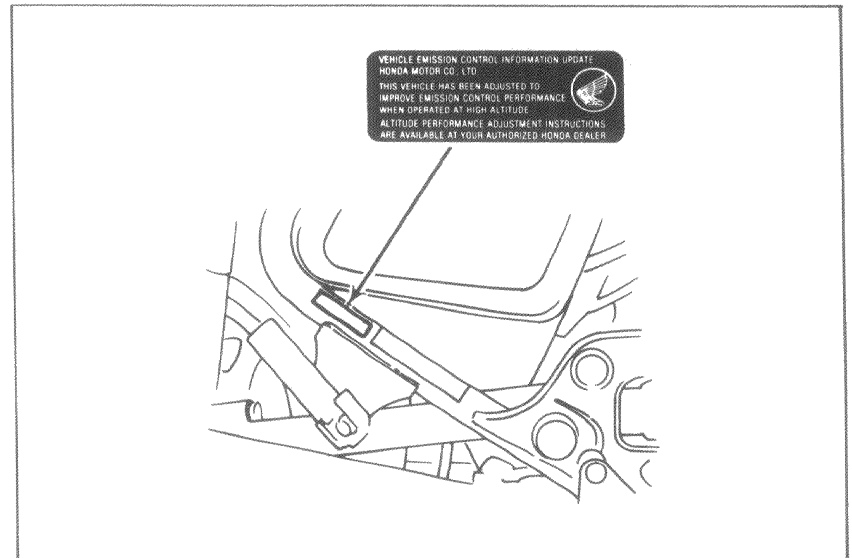
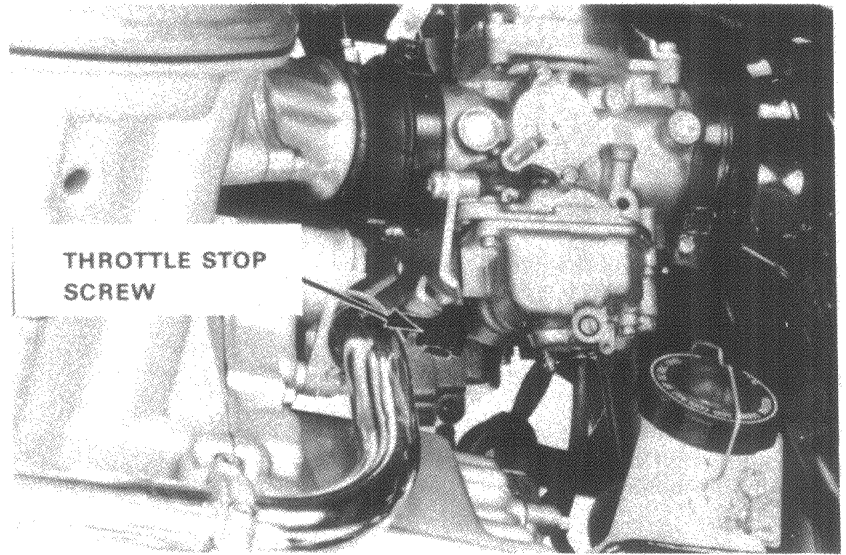



5. AC GENERATOR/ FLYWHEEL/REAR COVER

SERVICE INFORMATION GENERAL INSTRUCTIONS

- To inspect and adjust the pulse generator, see page 25-22.
- Be sure to adjust the ignition timing whenever the rear engine cover is removed.
- The starter motor and water impeller can be serviced with the engine installed in the frame. The swingarm must be removed first (see page 14-23).
- Take care not to cut the AC generator and starter wires and wire harness when removing or installing parts.

ENGINE REAR COVER

REAR COVER REMOVAL

Drain engine oil.

Remove the engine from the frame or remove the swingarm.

Remove the water pipe, gearshift pedal, drive shaft dust cover and starter motor.

Remove the water pump cover.

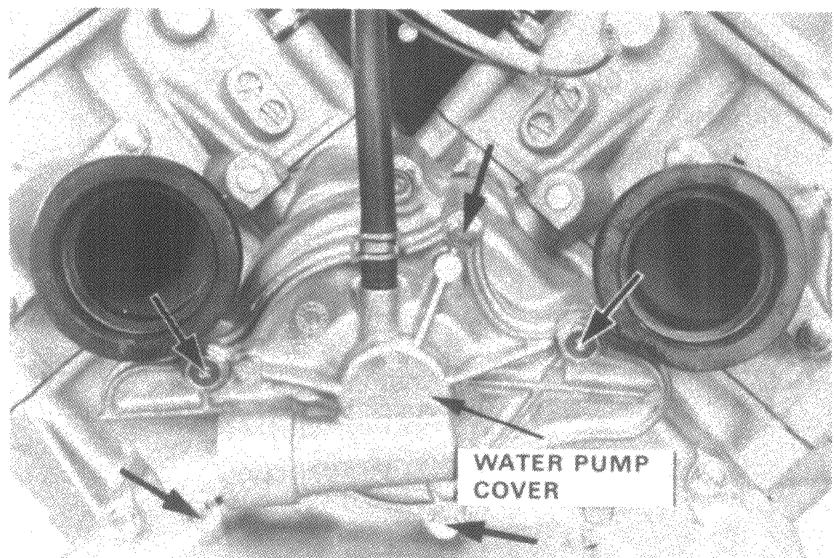
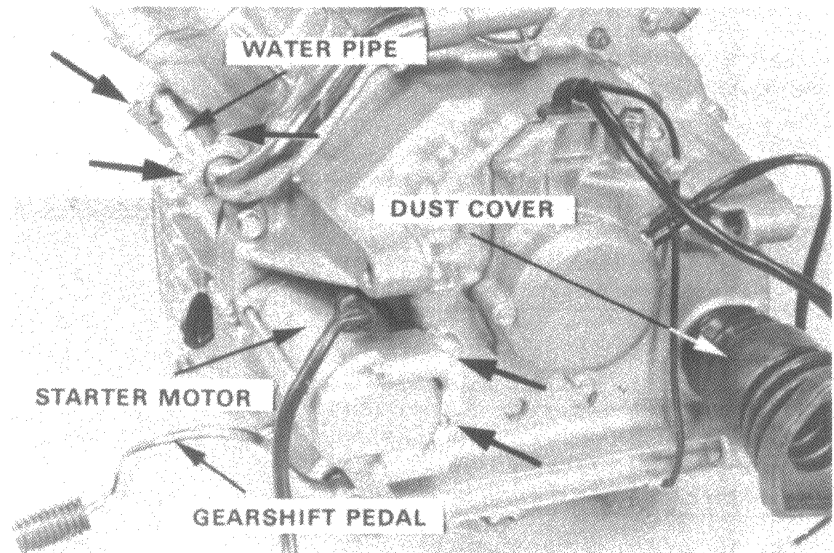



Remove the dowel pins.

Remove the cap nut, copper washer and pump impeller.

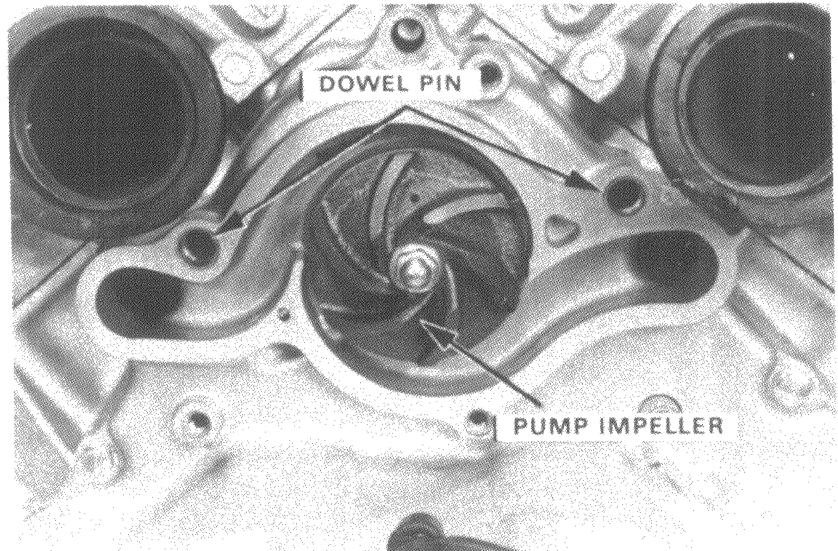

PULSE GENERATOR REMOVAL

Remove the pulse generator cover.

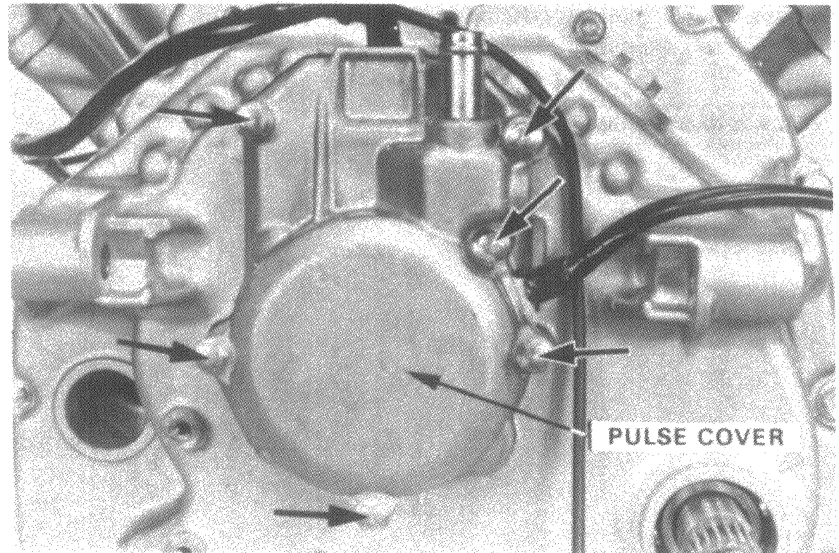

Remove the pulse generator by removing the two mounting screws.

Remove the spark advancer bolt and spark advancer.

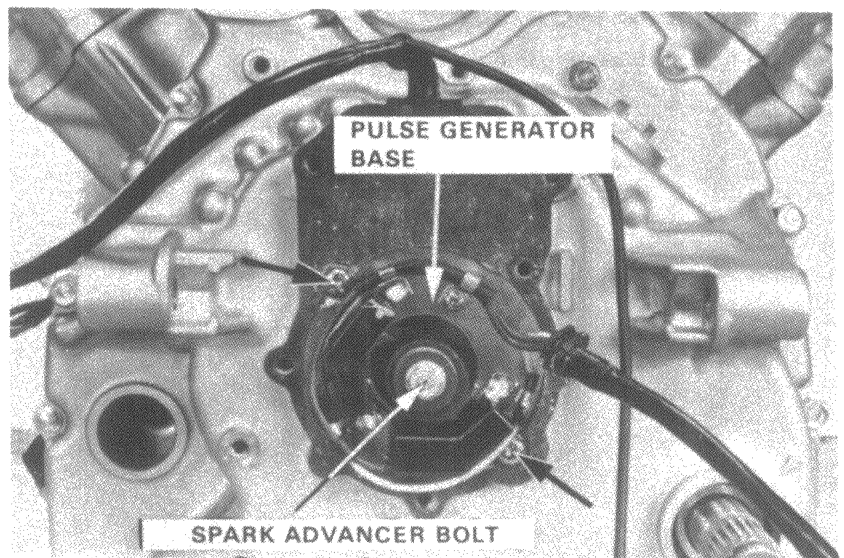



'82 ADDENDUM

Remove the neutral switch and the rear cover.

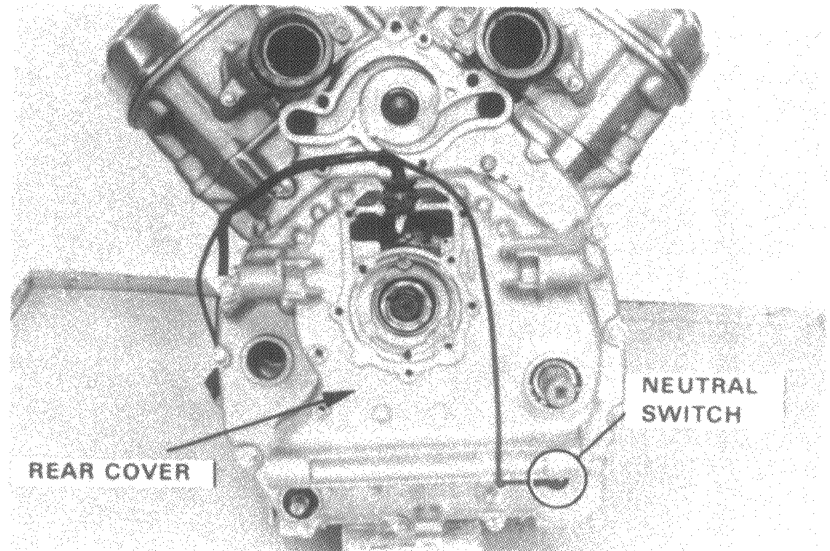

Remove the AC generator stator and remove the final shaft bearing.

NOTE

Do not damage the stator coil.

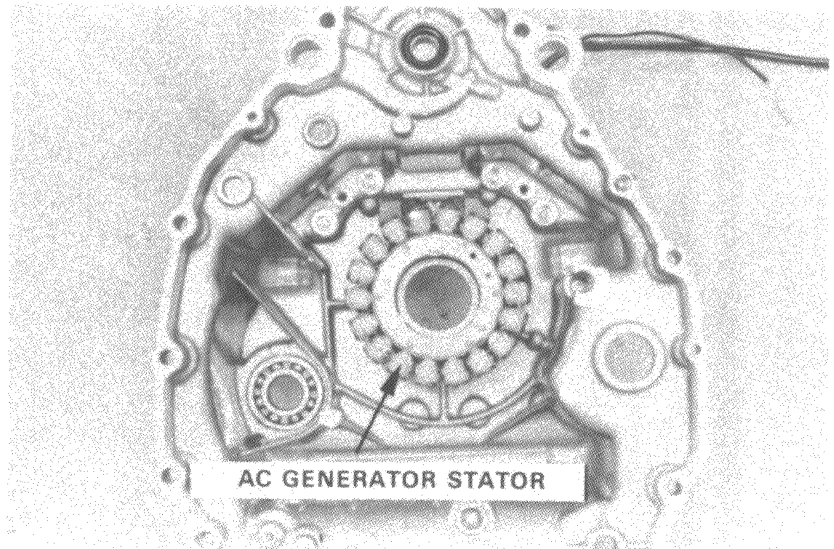

REAR COVER INSTALLATION

Drive the final shaft bearing into the rear cover. To install the water pump mechanical seal, refer to page 9-7.

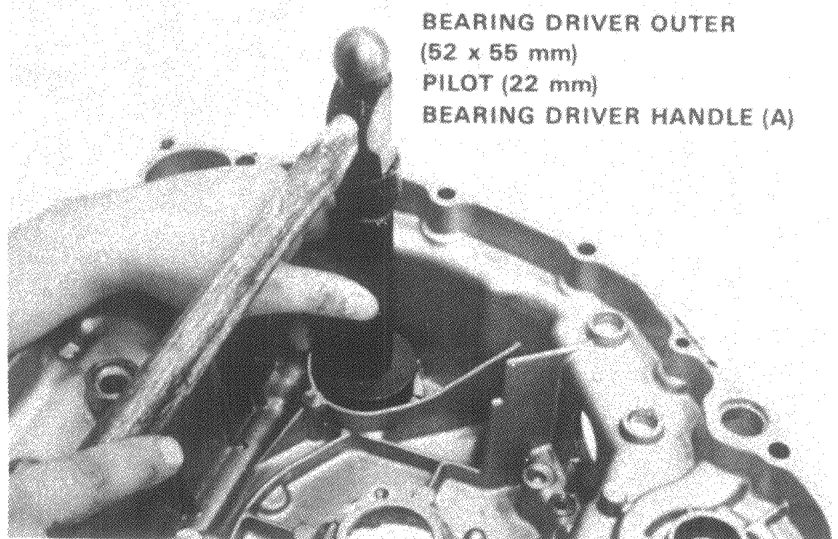



Engage the starter drive gear with the reduction gear.
Install the rear cover and torque the bolts to specification.

TORQUE:

6 mm bolts: 0.8-1.2 kg-m (6-9 ft-lb)

8 mm bolts: 1.8-2.5 kg-m (13-18 ft-lb)

NOTE

- Tighten the rear cover bolts in a criss-cross pattern in 2-3 steps.

Install the starter motor and neutral switch.

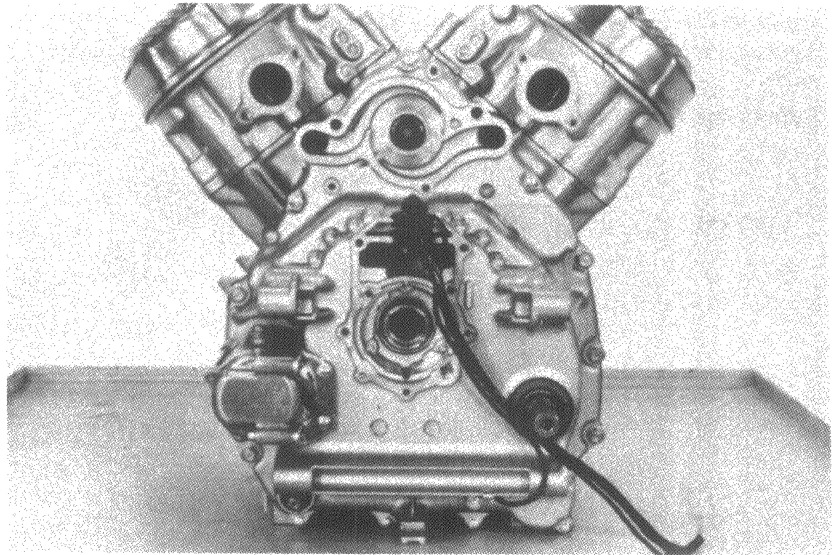

Install spark advancer. Align the lug on the advancer with the cut-out in the crankshaft.
Tighten the spark advancer attaching bolts.

TORQUE: 0.8-1.2 kg-m (6-9 ft-lb)

Install the swingarm (see page 14-27).

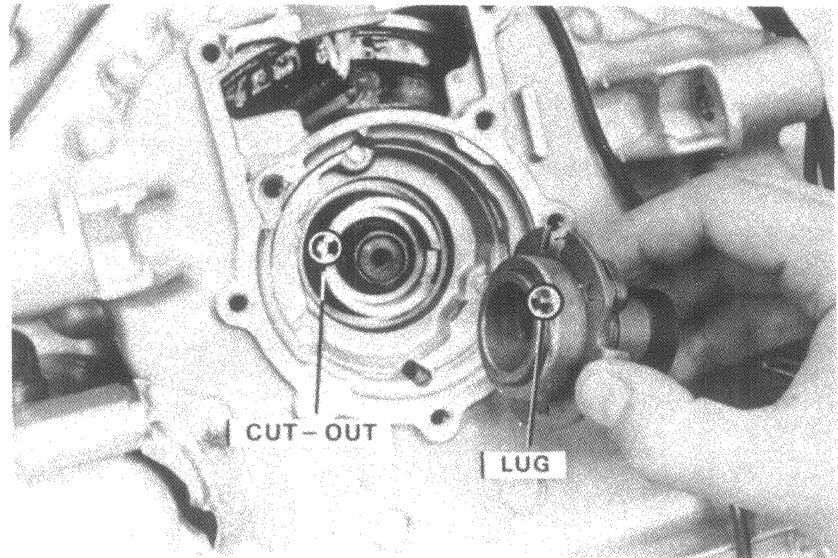

IGNITION TIMING ADJUSTMENT

Remove the timing inspection hole cap.

Rotate the crankshaft, and align the "FS" mark on the "TR" (right) side with the index mark on the rear cover.

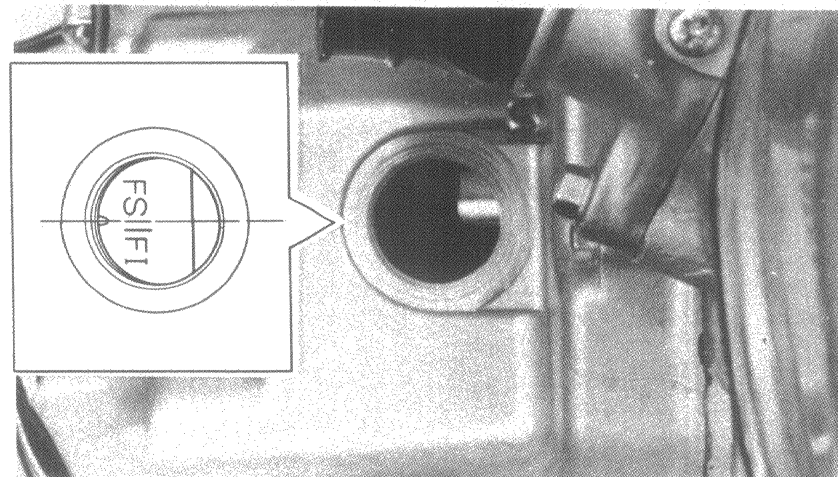
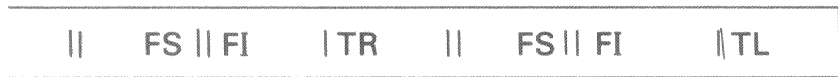



'82 ADDENDUM

Install the pulse generator assembly aligning the steel core on the coil case with the rotor tooth.

Tighten the screws securely.

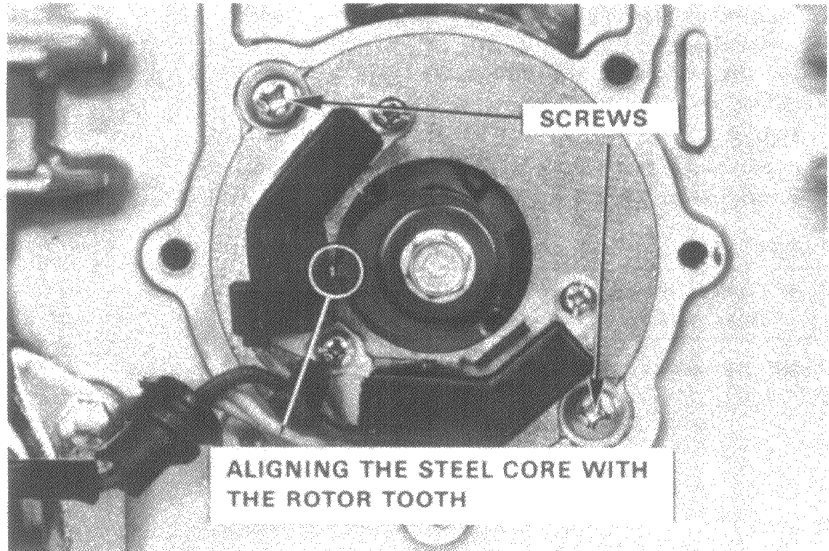

Rotate the crankshaft clockwise, and align the "FS" mark on the "TL" (left) side with the index mark on the rear cover. Check that the rotor tooth is aligned with the steel core on the lower coil case.

Check the air gap between the rotor tooth and the steel core.

AIR GAP: 0.40-0.70 mm (0.016-0.028 in)

For air gap adjustment, refer to page 25-22.

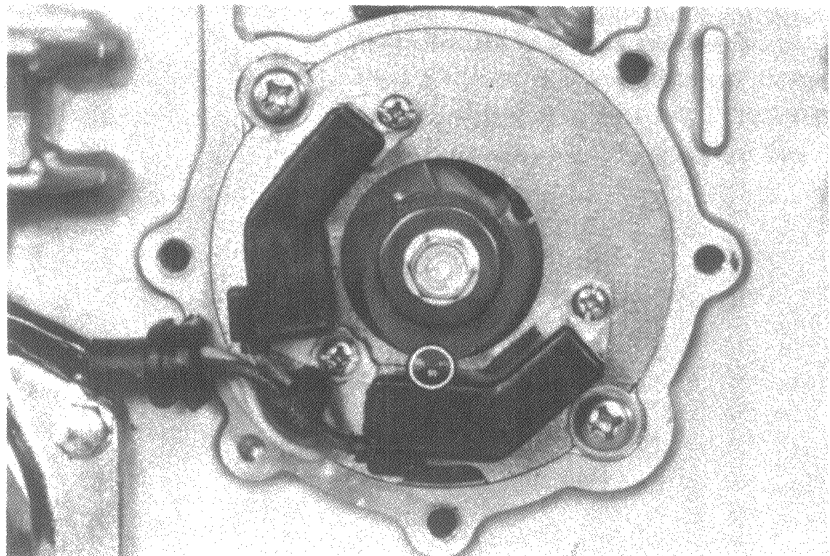

Install the pump impeller, water pump cover and water pipe.

Install the pulse generator cover.

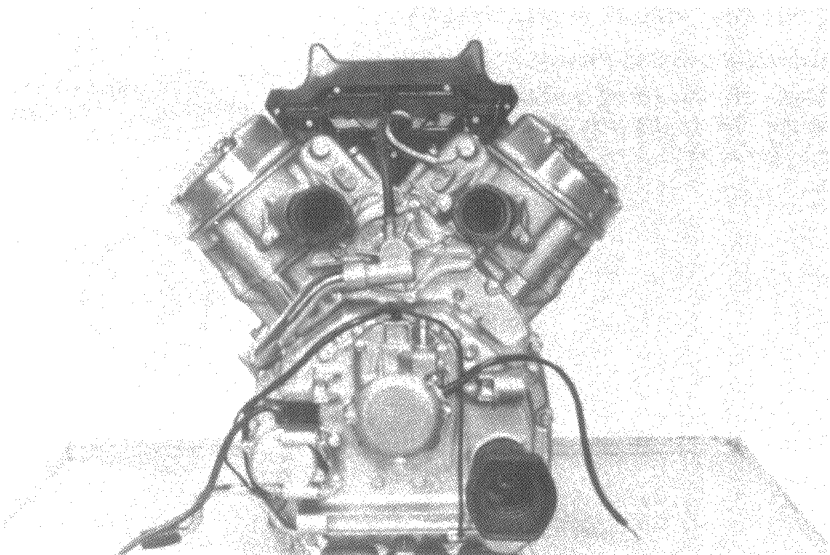



6. FRONT BRAKE

SPECIFICATIONS

ITEM	STANDARD	SERVICE LIMIT
Disc plate thickness	5 mm (0.20 in)	4 mm (0.16 in)
Disc plate runout	————	0.3 mm (0.01 in)
Master cylinder I.D.	15.870-15.913 mm (0.6248-0.6245 in)	15.925 mm (0.6270 in)
Master piston O.D.	15.827-15.857 mm (0.6231-0.6243 in)	15.815 mm (0.6226 in)
Caliper piston O.D.	30.148-30.149 mm (1.1869-1.1889 in)	30.140 mm (1.1866 in)
Caliper cylinder I.D.	30.230-30.280 mm (1.190-1.1921 in)	30.290 mm (1.1925 in)

BRAKE PAD REPLACEMENT

Remove the lock bolt and the pin retainer.

Slowly press the caliper against the disc to push the pistons back into their cylinders. This is necessary to make room for the increased thickness of the new pads.

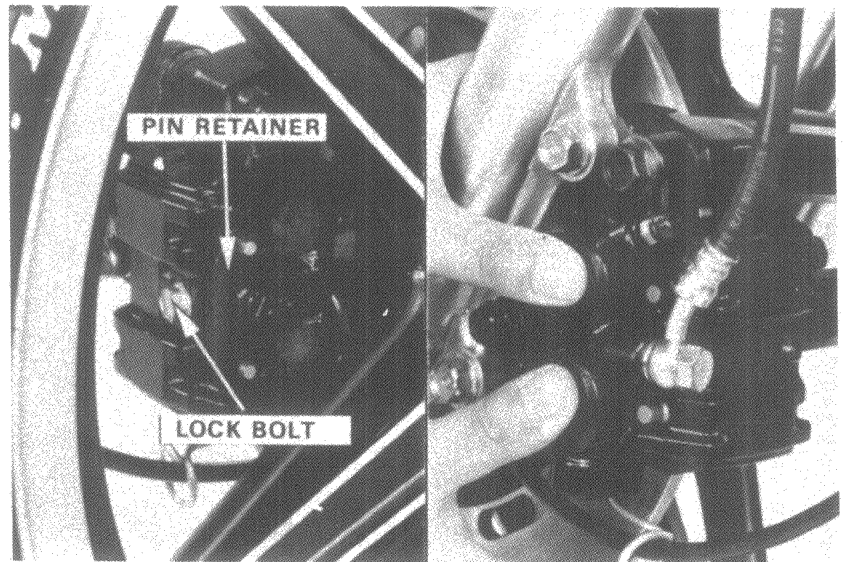

Remove the caliper mounting bolt.

Remove the caliper shaft and brake caliper.

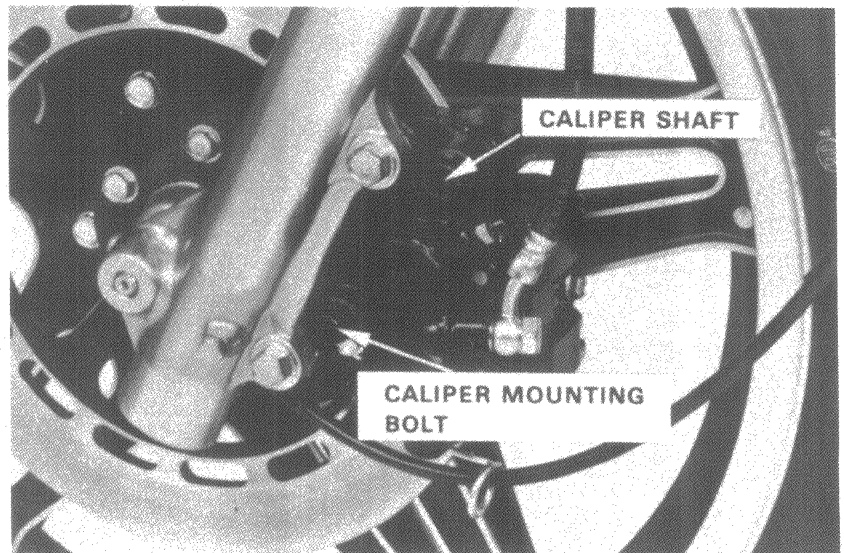



'82 ADDENDUM

Pull out the brake pad pins and remove the brake pads.

Install new brake pads and insert the brake pad pins.

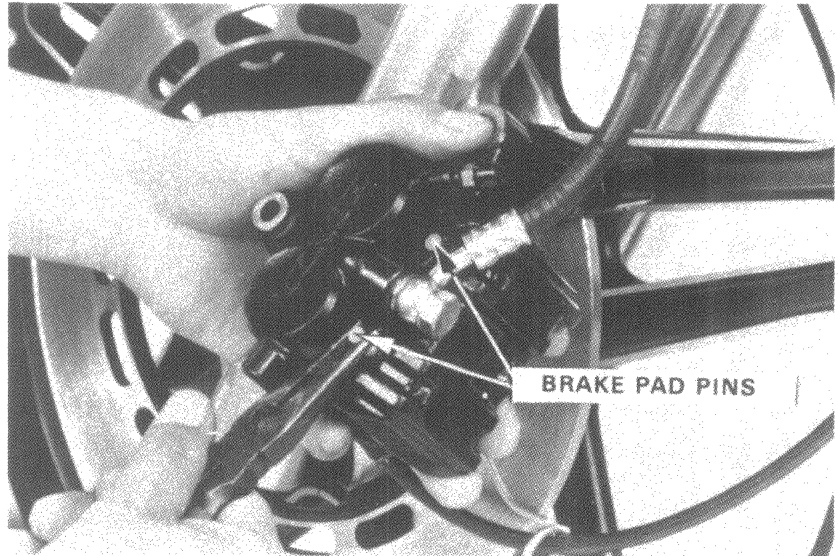

Install the caliper shaft into the caliper.

Install the caliper.

Tighten the caliper mounting bolt and the caliper shaft to specified torque.

TORQUE:

CALIPER MOUNTING BOLT: 2.0-2.5 kg-m
(14-18 ft-lb)

CALIPER SHAFT: 2.5-3.0 kg-m
(18-22 ft-lb)

Install the brake pad pin retainer.

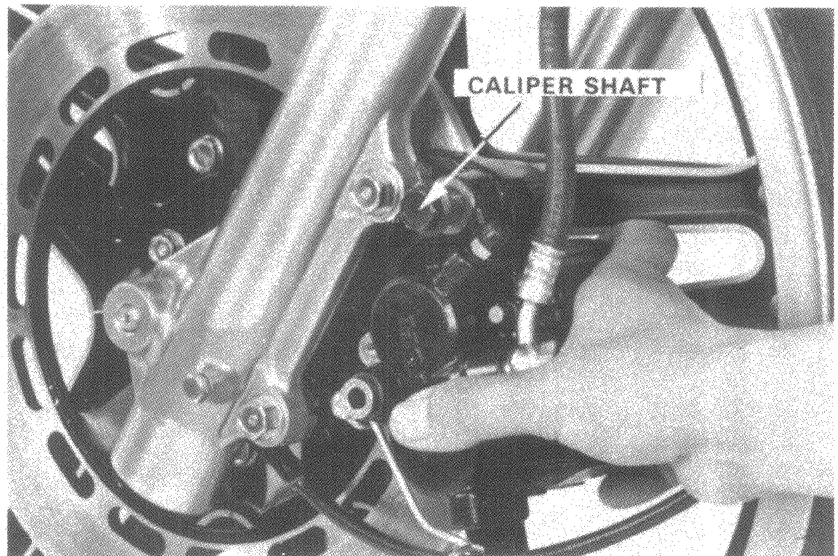

BRAKE CALIPER DISASSEMBLY

Place a container under the caliper and disconnect the brake hose bolt.

NOTE

Avoid spilling brake fluid on painted surfaces.

Remove the brake pads.

Remove the caliper shaft and caliper mounting bolt.

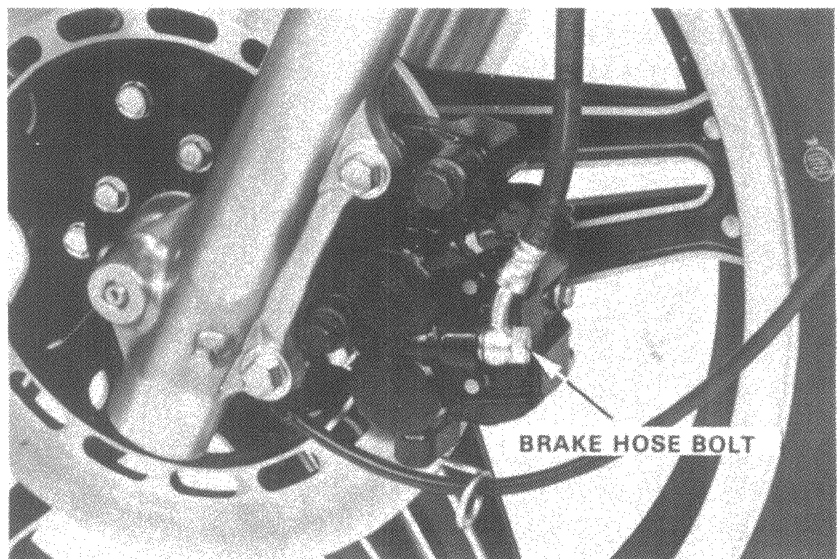



Remove the collar and boot.
Remove the pad spring.

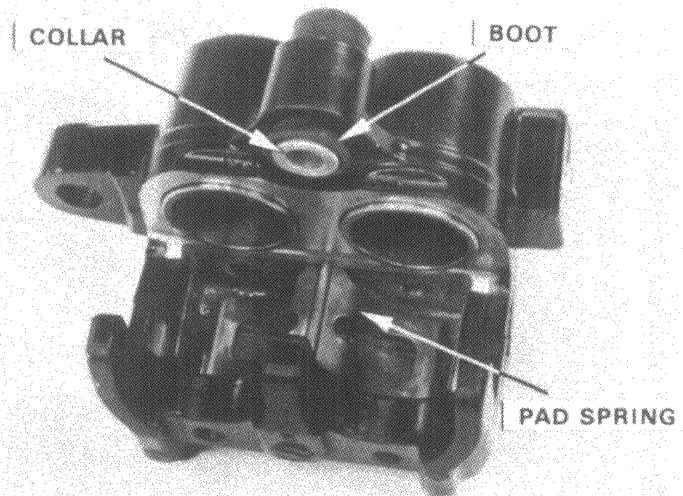

Place a shop towel over the pistons and position the caliper with the pistons down.
Remove the pistons by applying a small amount of air pressure to the fluid inlet.

WARNING

Do not use high pressure air or bring the nozzle too close to the inlet.

Examine the pistons and cylinders for scoring or scratches and replace if necessary.

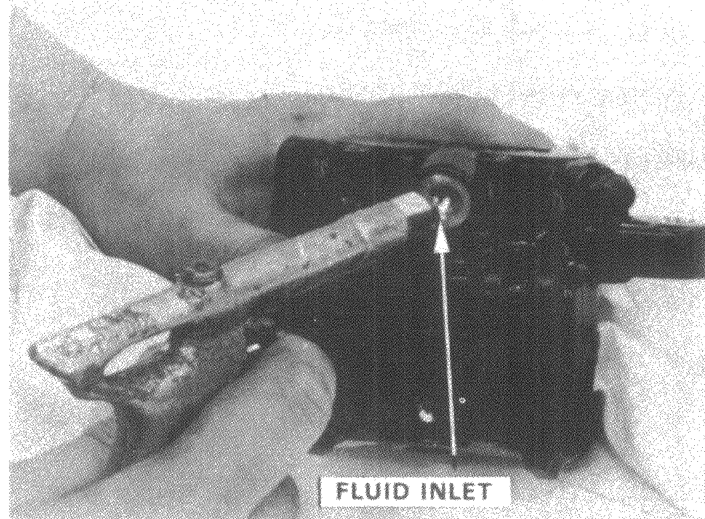

Remove the oil seals from the cylinders as shown.
Clean the caliper grooves with brake fluid.

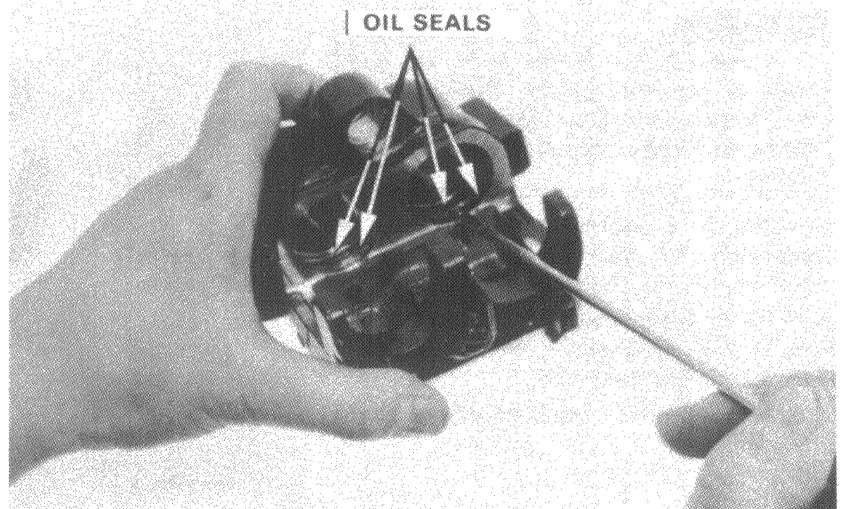



'82 ADDENDUM

INSPECTION

CALIPER PISTON O.D.

Check each piston for scoring or scratches.
Measure the outside diameter of each piston with a micrometer.

SERVICE LIMIT: 30.140 mm (1.1866 in)

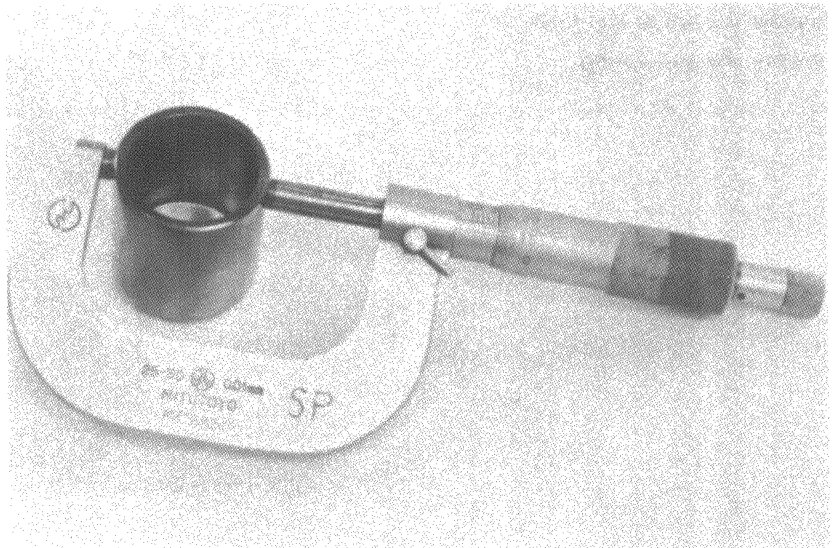

CALIPER CYLINDER I.D.

Check each caliper cylinder for scoring or scratches.
Measure the inside diameter of each caliper cylinder bore.

SERVICE LIMIT: 30.290 mm (1.1925 in)

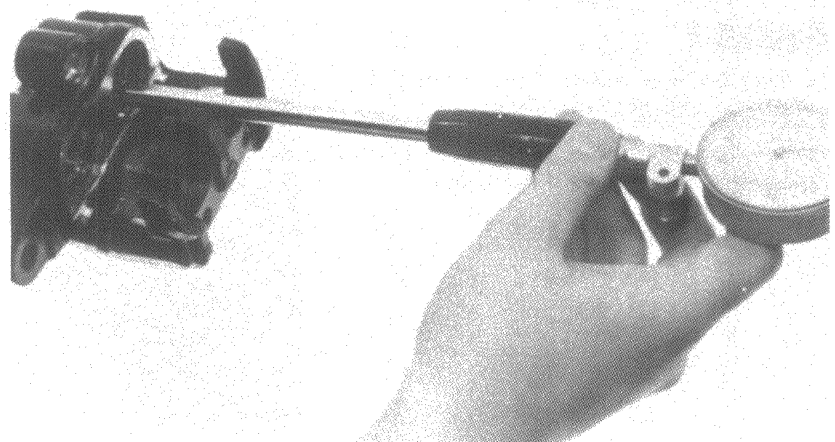

ASSEMBLY

WARNING

A contaminated brake disc or pad reduces stopping power. Replace contaminated pads, and clean a contaminated disc with a good quality degreasing agent.

Assemble the caliper in the reverse order of disassembly. The oil seals must be replaced whenever they are removed.

Lubricate the pistons and seals with a medium grade of high temperature silicon grease or brake fluid before assembly.

Make sure the piston seals are seated in the caliper grooves.

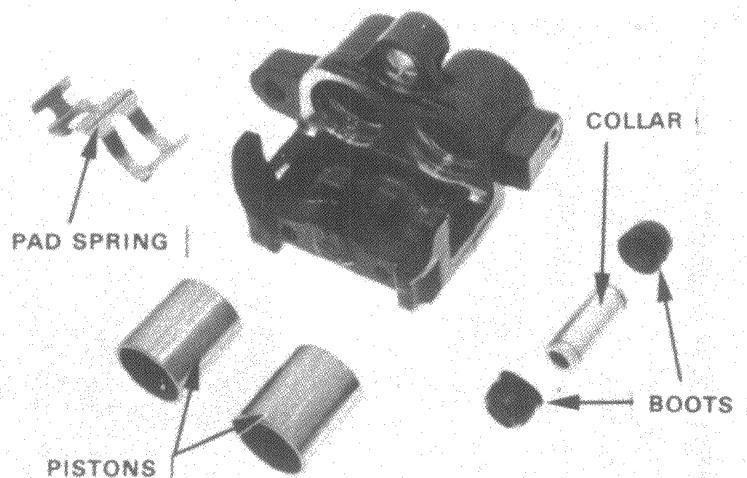



CALIPER BRACKET INSPECTION

Remove the dust cover from the caliper bracket and check it for damage.

Check that the caliper bracket plate is correctly seated on the bracket.

If necessary, cement the plate to the bracket with Loctite 601 or an equivalent cement.

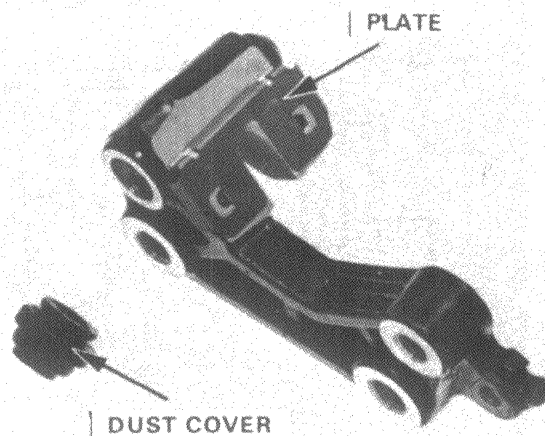

CALIPER INSTALLATION

Install the brake pads and the caliper.

Tighten the caliper mount bolt and caliper shaft to the specified torque.

TORQUE:

CALIPER MOUNT BOLT: 2.0-2.5 kg-m
(14-18 ft-lb)

CALIPER SHAFT: 2.5-3.0 kg-m
(18-22 ft-lb)

Connect the brake hose.

Fill the brake fluid reservoir and bleed the front brake system (see page 3-10).

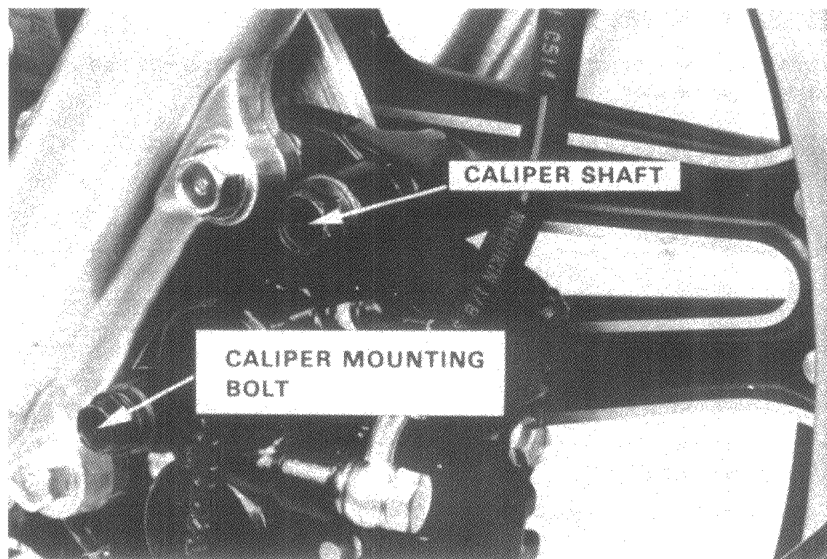



6. IGNITION SYSTEM

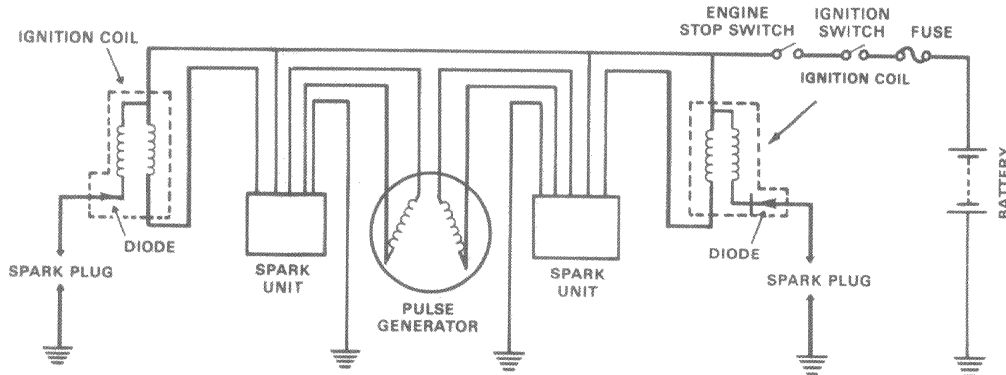

SERVICE INFORMATION

GENERAL INSTRUCTION

A transistorized ignition system is used and no adjustments are to be made unless the pulse generator screws are loosened or the pulse generator is removed.

SPECIFICATIONS

ITEM		SPECIFICATION
Spark plug	Standard	DR8ES-L (NGK) or X24ESR-U (ND)
	For extended high-speed riding	DR8ES (NGK) or X27ESR-U (ND)
Spark plug gap		0.6-0.7 mm (0.024-0.028 in)
Ignition timing	"F" mark	15° BTDC/1,100 ± 100 rpm
	Full advance	40° ± 1.5° BTDC/2,780 rpm
Pulse generator air gap		0.40-0.70 mm (0.016-0.028 in)
Ignition coil 3-point spark test		6 mm (1/4 in) minimum

TROUBLESHOOTING

Engine cranks but will not start

- Engine stop switch OFF.
- No spark at plugs
- Faulty transistorized spark unit
- Faulty pulse generator

No spark at plug

- Engine stop switch OFF
- Poorly connected, broken or shorted wires
 - Between ignition switch and engine stop switch
 - Between spark unit and engine stop switch
 - Between spark unit and ignition coil
 - Between ignition coil and plug
 - Between spark unit and pulse generator
- Faulty ignition coil
- Faulty ignition switch
- Faulty spark unit
- Faulty pulse generator

Engine starts but runs poorly

- Ignition primary circuit
 - Faulty ignition coil
 - Loose or bare wire
 - Intermittent short circuit
- Secondary circuit
 - Faulty plug
 - Faulty high tension cord
- Timing advance incorrect
 - Centrifugal advancer faulty



**IGNITION COIL
REMOVAL**

Remove the seat and fuel tank.
Disconnect the ignition switch couplers.
Remove the ignition coils attaching bolts and
remove the coils.

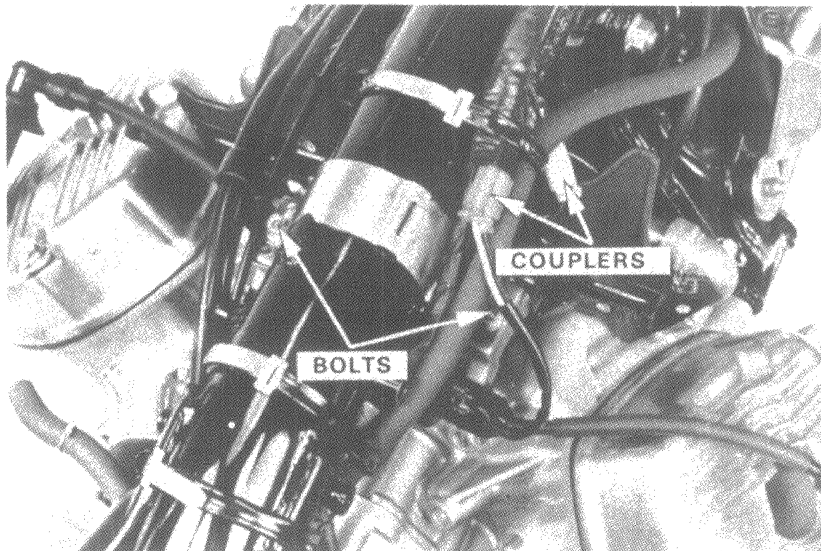

PERFORMANCE TEST

Perform a 3-point spark test with a coil tester.

SERVICE LIMIT: 6 mm (1/4 in) min

NOTE

Follow the coil tester manufacturer's
instructions.

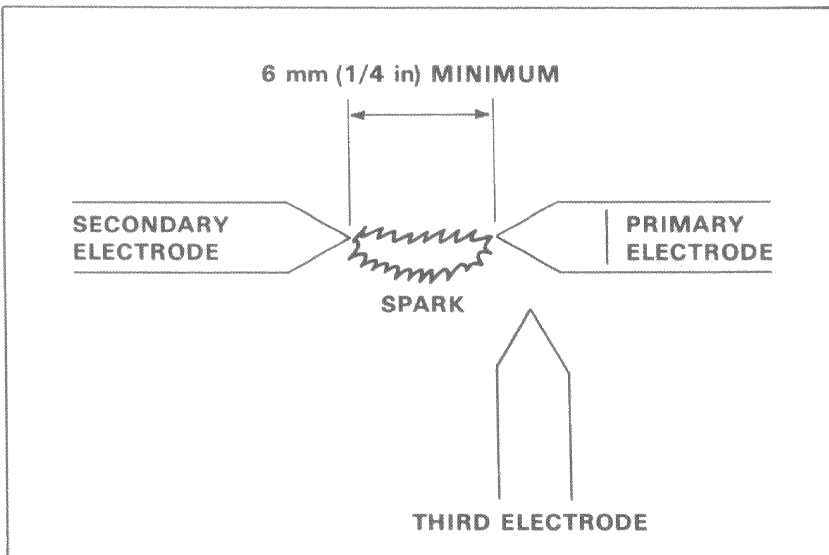

PRIMARY COIL INSPECTION

Check the resistance of each ignition coil
between the leads with an ohmmeter as shown.

RESISTANCE: 2-3 Ω

Replace the coil if the resistance exceeds the
specified range.

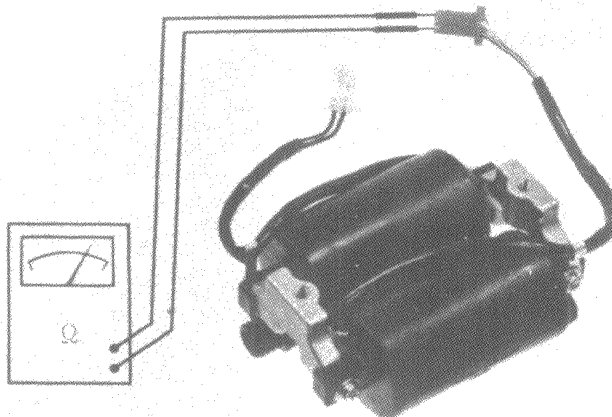



'82 ADDENDUM

SECONDARY COIL INSPECTION

Measure the resistance between the black/white terminal of the coupler and the high-tension terminal.

NOTE

- Use SANWA tester (07308-0020000) or KOWA tester (TH-5H-1)
- Use serviceable batteries for this test.

Test 1. Connect the negative probe of the tester to the coupler terminal and the positive probe to the high-tension terminal and measure the resistance.

RESISTANCE: SANWA TESTER:
200-350 k Ω
KOWA TESTER: 50-200 k Ω

Test 2. Reverse the tester polarities and measure the resistance.

RESISTANCE: ∞

Replace the ignition coil if the resistances of tests 1 and 2 exceed the limits.

TRANSISTORIZED IGNITION SYSTEM INSPECTION

Disconnect the spark plugs.

Hold each plug against any convenient engine ground.

Turn the ignition switch ON and run the engine with the starter motor.

A good spark to the plug means that the ignition system is in good condition.

If it is not, inspect the pulse generator, spark unit and spark advancer.

PULSE GENERATOR

Measure the pulse coil resistance between the yellow leads (right cylinder), and between the blue leads (left cylinder) in the coupler.

COIL RESISTANCE: 530 \pm 50 at 20°C (68°F)

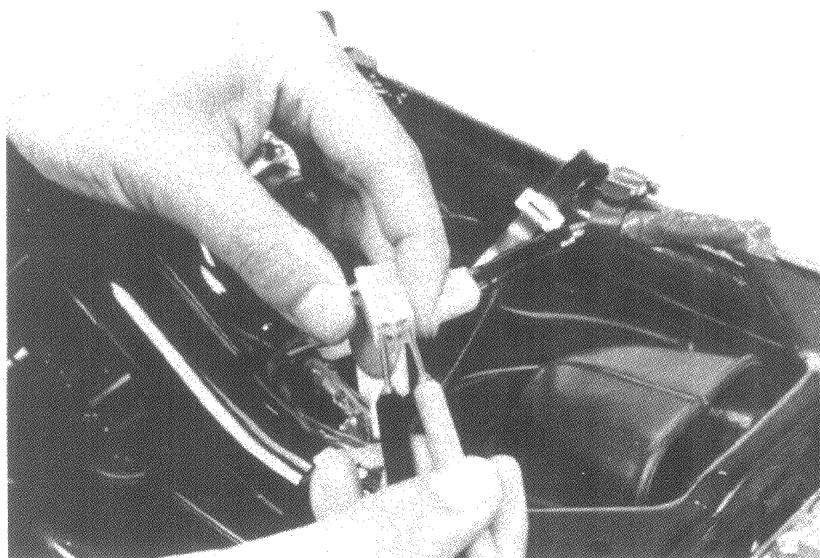
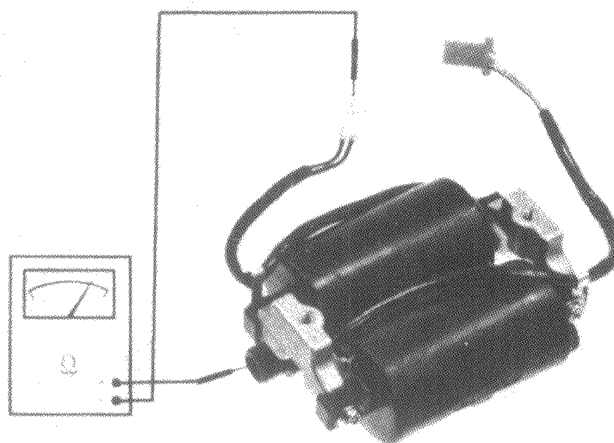



SPARK UNIT

Disconnect the wire at the pulse generator coupler.

Attach the positive lead of a voltmeter to the blue with yellow tube wire terminal (left) or yellow with white tube wire terminal (right) of the 6-pole coupler. Attach the negative lead to any convenient ground. Turn the ignition switch on.

Ground each corresponding terminal, blue with white tube wire terminal (left), or yellow with white tube wire terminal (right) of the 4-pole coupler intermittently.

The transistor unit is normal if the voltage indicated by the voltmeter changes from 12V to 0V in each test.

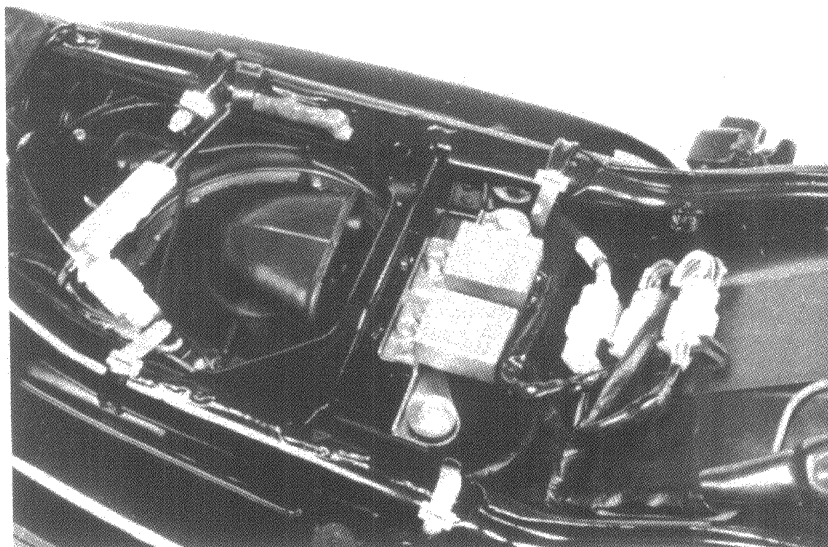

SPARK ADVANCER

Remove the pulse generator (see page 25-9).

Check the mechanical advancer cam for sticking.

Lubricate the sliding surfaces, and check the spring for loss of tension and the advancer pin for excessive wear.

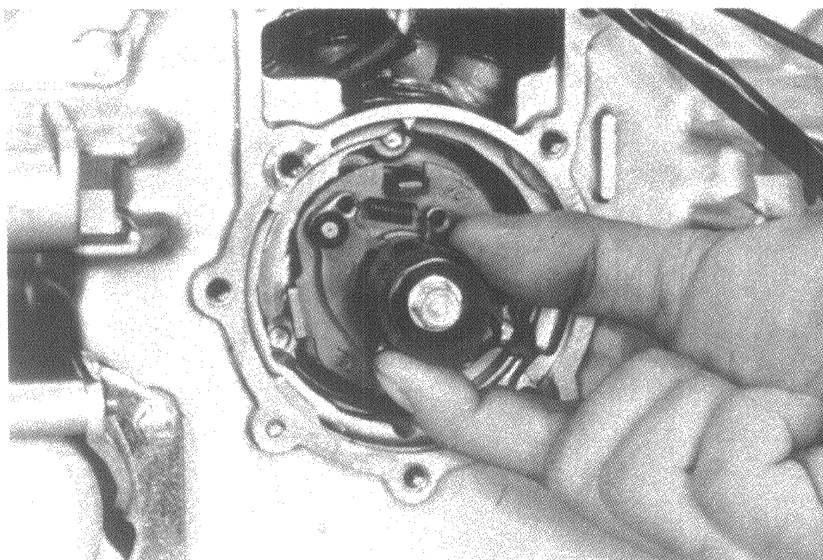

SPARK ADVANCER ASSEMBLY

When assembling, align the rotor tooth with the cut-out in the advancer.

Install the spark advancer.

Install the pulse generator and adjust the ignition timing (see page 25-11).

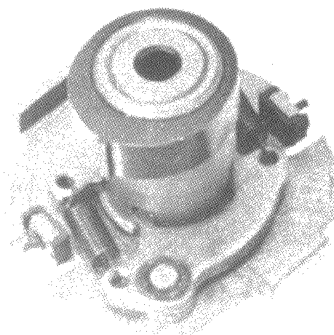



'82 ADDENDUM

**PULSE GENERATOR AIR GAP
ADJUSTMENT**

Measure the air gaps between the rotor tooth and the pulse generator coils.

AIR GAP: 0.40-0.70 mm (0.016-0.028 in)

When adjustment is necessary, loosen the screws and move the coil to achieve the correct gap.

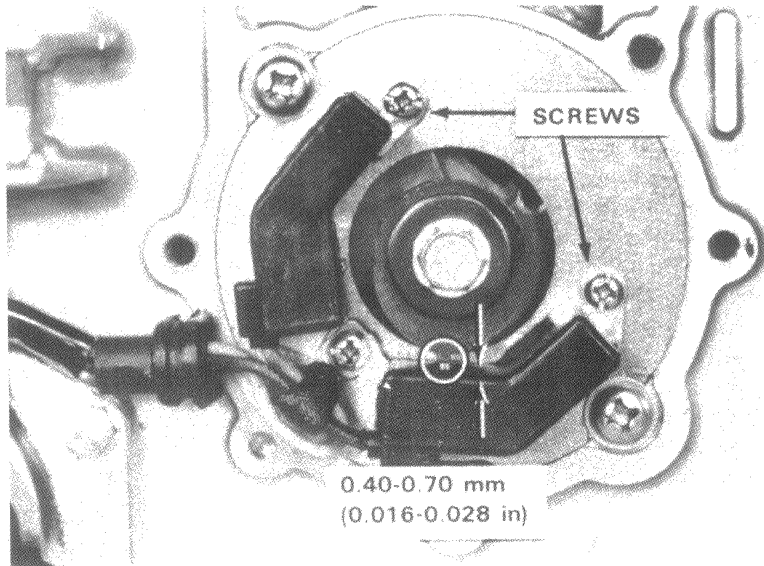

IGNITION TIMING CHECK

Remove the timing hole cap.

Connect a timing light to the right cylinder and connect a tachometer.

Start the engine and check the ignition timing.

The index mark should be aligned with the FI (for "idle") mark at $1,100 \pm 100$ rpm.

Timing advance should start at $1,500 \pm 100$ rpm.

The index mark should be between the full advance marks at 2,780 rpm.

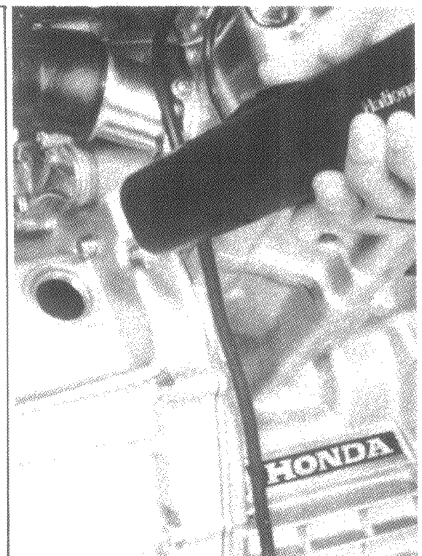
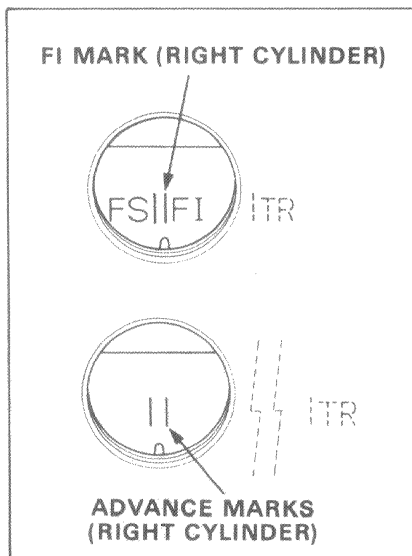

Repeat for the left cylinder, using the left cylinder timing marks.

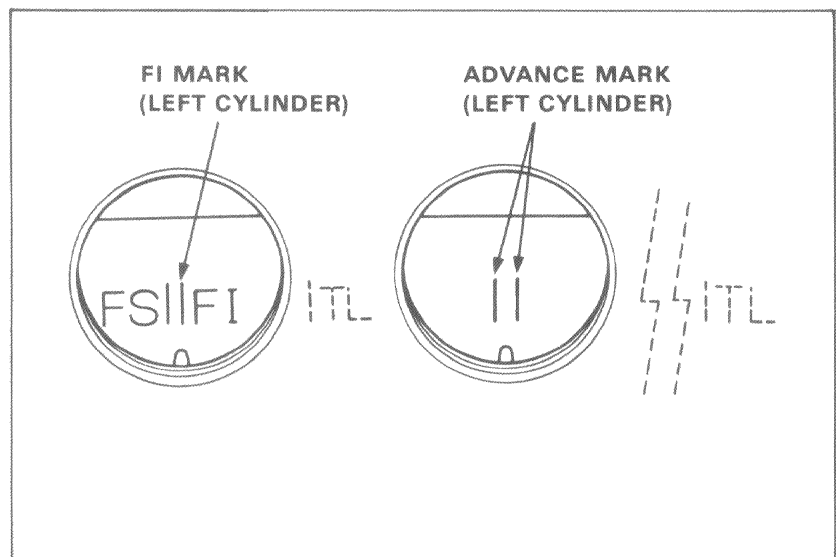



8. WIRING DIAGRAM

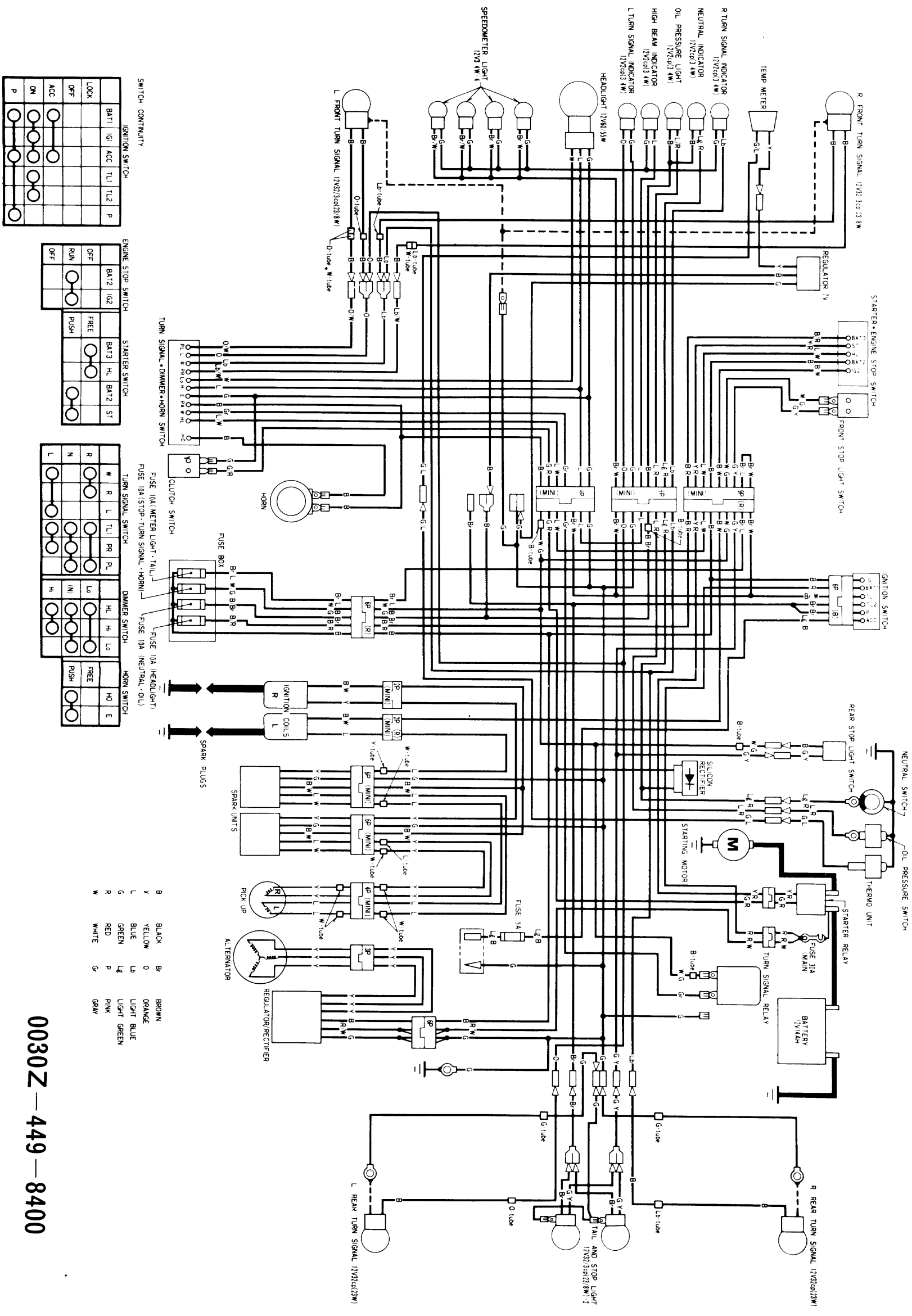

0030Z-449-8400