



4. FUEL SYSTEM

| | | | |
|----------------------------------------|-----|-----------------------------|------|
| SERVICE INFORMATION | 4-1 | COMPONENT ASSEMBLY | 4-8 |
| TROUBLESHOOTING | 4-1 | FLOAT LEVEL ADJUSTMENT | 4-9 |
| CARBURETOR REMOVAL | 4-2 | FAST IDLE ADJUSTMENT | 4-9 |
| CARBURETOR SEPARATION | 4-3 | CARBURETOR INSTALLATION | 4-9 |
| CARBURETOR ASSEMBLY | 4-4 | PILOT SCREW INITIAL SETTING | 4-10 |
| VACUUM CYLINDER DISASSEMBLY/INSPECTION | 4-5 | FUEL TANK | 4-11 |
| FLOAT CHAMBER DISASSEMBLY | 4-6 | AIR CLEANER CASE | 4-11 |
| AIR CUTOFF VALVE DISASSEMBLY | 4-8 | CRANKCASE BREATHER SYSTEM | 4-12 |

SERVICE INFORMATION

• WORKING PRACTICE

Use caution when working with gasoline. Always work in a well-ventilated area and away from sparks or open flames. When disassembling fuel system parts, note the locations of the O-rings. Replace them with new ones on reassembly.

The float bowls have drain plugs that can be loosened to drain residual gasoline.

• SPECIAL TOOL

FLOAT GAUGE 07401-0010000

• SPECIFICATIONS

| ITEM | STANDARD |
|------------------------------------------------|---------------------------|
| Venturi diameter | 35 mm (1.38 in.) |
| Setting mark | VB26A |
| Float level | 15.5 mm (0.61 in.) |
| Pilot screw | See Page 4-10 |
| Idle speed | 1,100 ± 100 rpm |
| Vacuum pressure difference between carburetors | 40 mm Hg |
| Throttle grip free play | 2 - 6 mm (1/8-1/4 in.) |

TROUBLESHOOTING

Engine Cranks But Won't Start

1. No fuel in tank
2. No fuel getting to cylinders
3. Too much fuel getting to cylinders
4. No spark at plugs - ignition malfunction
5. Air cleaner clogged

Engine Idles Roughly, Stalls, or Runs Poorly

1. Idle speed incorrect
2. Ignition malfunction
3. Low compression
4. Rich mixture
5. Lean Mixture
6. Air cleaner clogged
7. Air leaking into manifold

8. Fuel contaminated
9. Carburetors not synchronized
10. Faulty vacuum piston

Lean Mixture:

1. Carburetor fuel jets clogged
2. Vacuum piston stuck closed
3. Fuel cap vent blocked
4. Fuel filter clogged
5. Fuel line blocked
6. Float valve faulty
7. Float level too low

Rich Mixture:

1. Choke stuck closed
2. Float level set too high or float sticking
3. Carburetor air jets clogged
4. Sticking float
5. Dirty air cleaner



FUEL SYSTEM

CARBURETOR REMOVAL

- Turn the fuel valve off.
- Remove the seat and fuel tank.
- Remove the wire band, breather hose, bypass hose, and choke wire clamp.
- Remove the carburetor band.
- Remove the carburetor insulator.

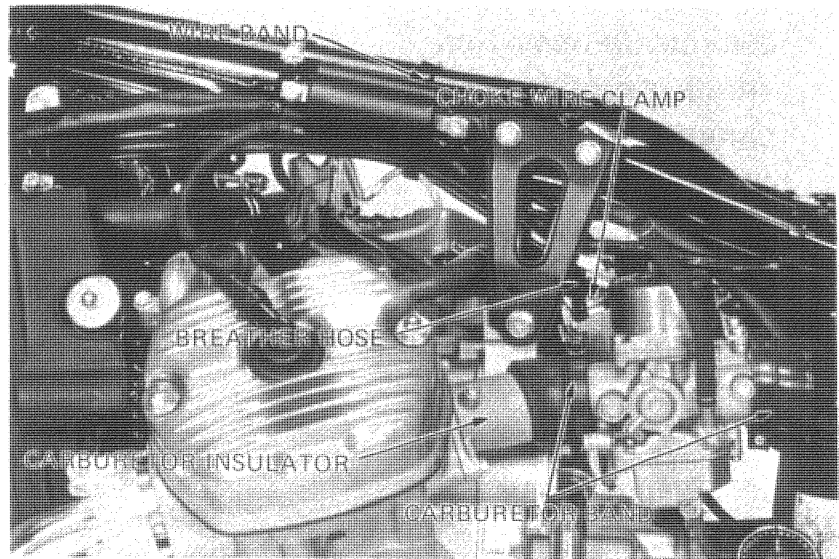

Remove both carburetors from the air cleaner tube by pushing them down and forward.

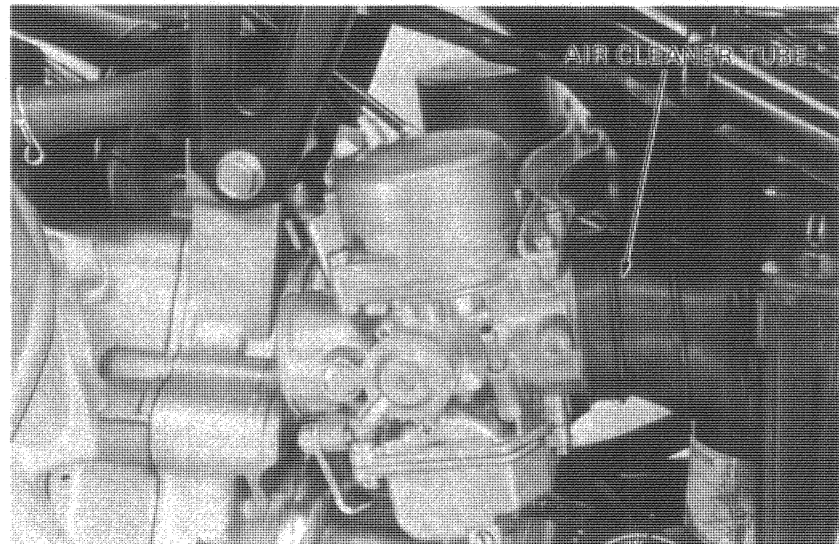

- Pull the carburetors towards the left.
- Loosen the lock nuts and disconnect the throttle cables.
- Disconnect the choke cable at the carburetors.
- Remove the carburetors.

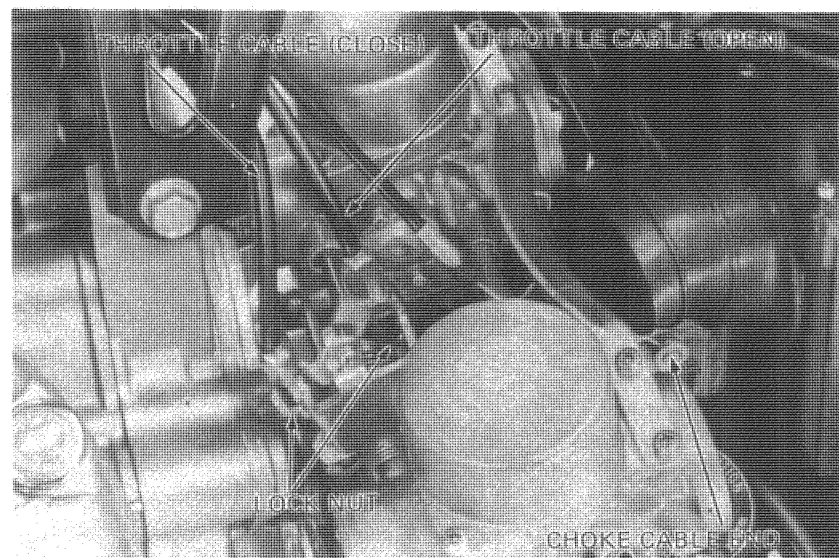



CARBURETOR SEPARATION

CAUTION

The carburetor is pre-set at the factory and pilot screw adjustment is not necessary except after overhauling it.

Remove the synchronization adjustment screw.

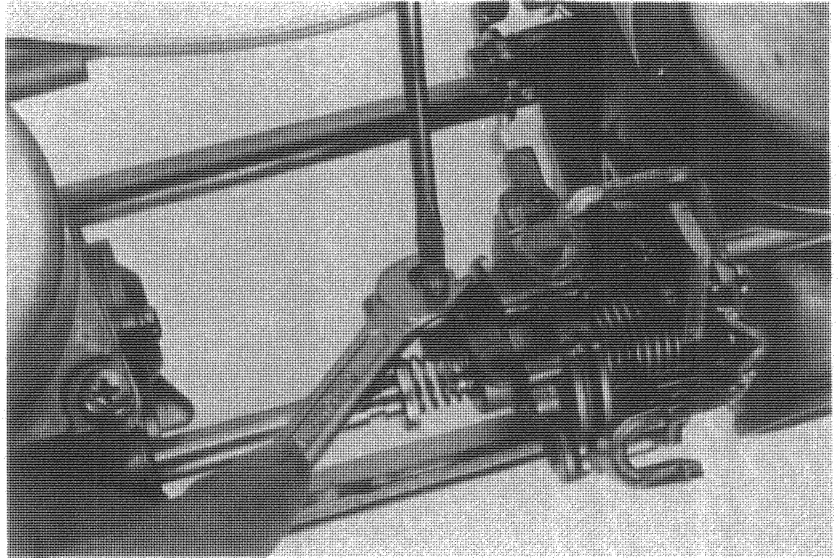

Remove the choke relief spring.

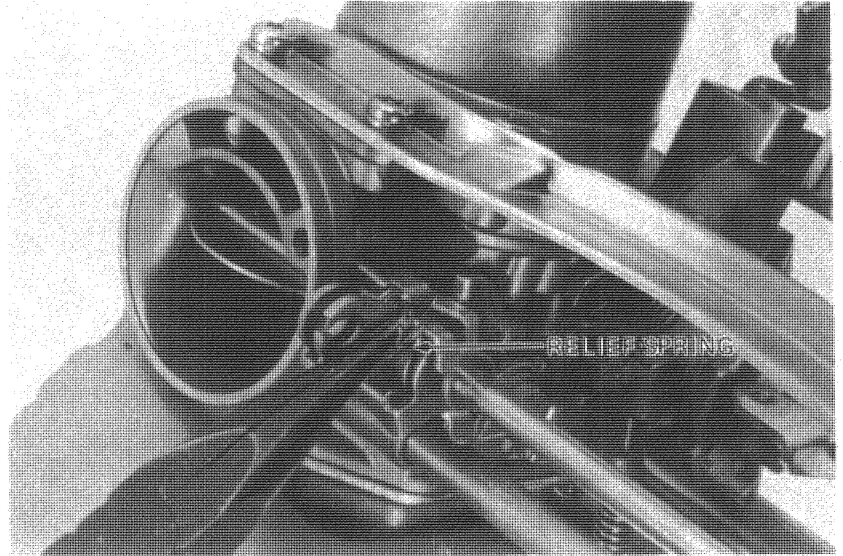

Remove the rear stay.

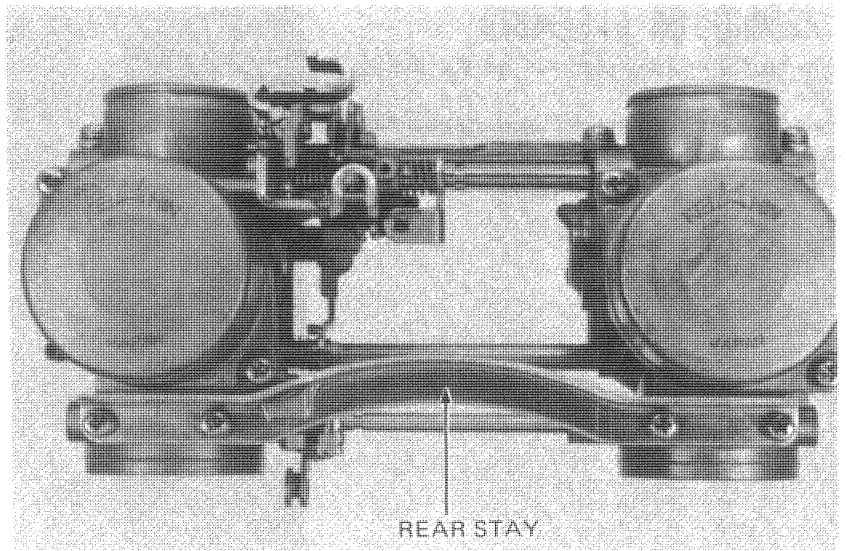



FUEL SYSTEM

Remove the front stay plate.

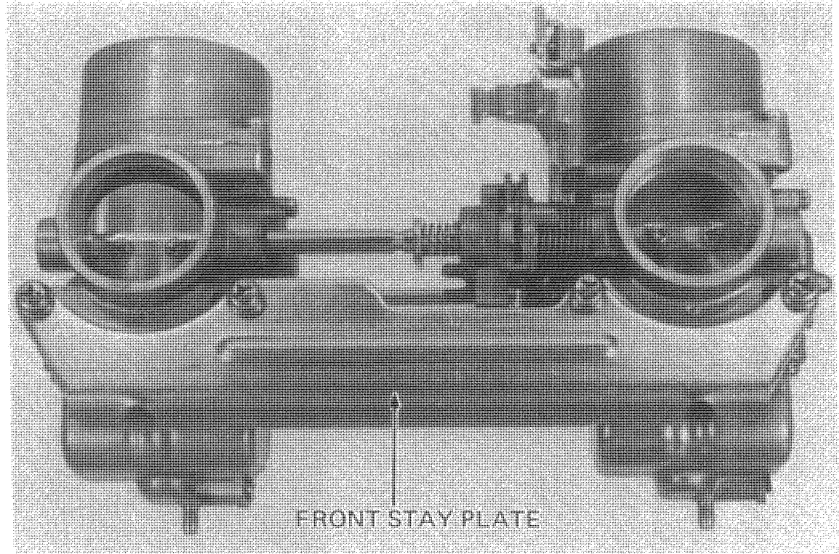

Separate the carburetors.

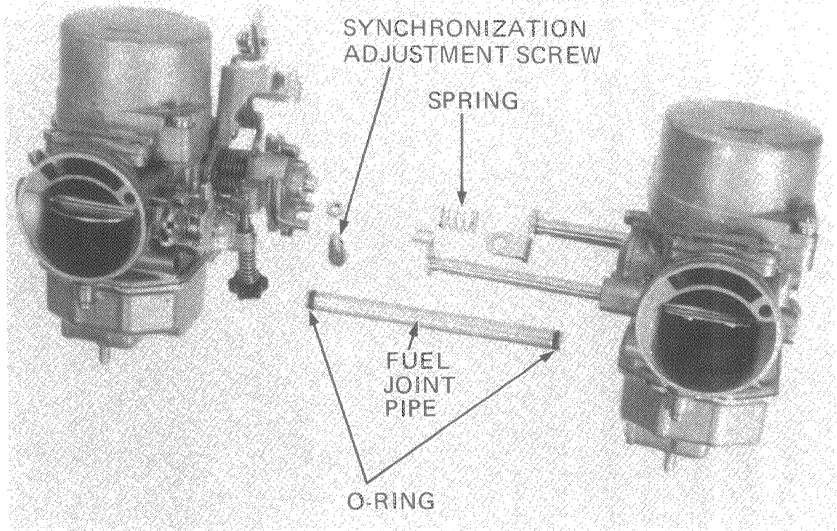

CARBURETOR ASSEMBLY

Slip an O-ring over each end of the fuel joint pipe.

Assemble the right and left carburetors making sure the spring are properly positioned.

Install the synchronization adjustment screw.

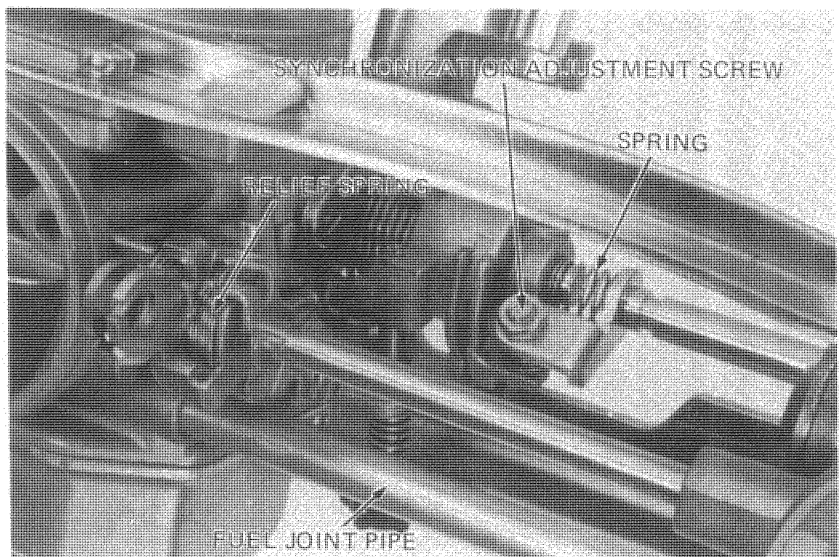



VACUUM CYLINDER DISASSEMBLY/INSPECTION

Remove the vacuum cylinder from the carburetor.
Remove the vacuum piston and inspect for wear, nicks, or scratches.
Make sure the piston moves freely in the cylinder and in the bore of the carburetor.

Remove the full open stopper.
Remove the needle set screw and the jet needle.

NOTE

Inspect the needle and seat for deposits, grooves, or other damage.
Carefully lift the seal ring off the carburetor body.

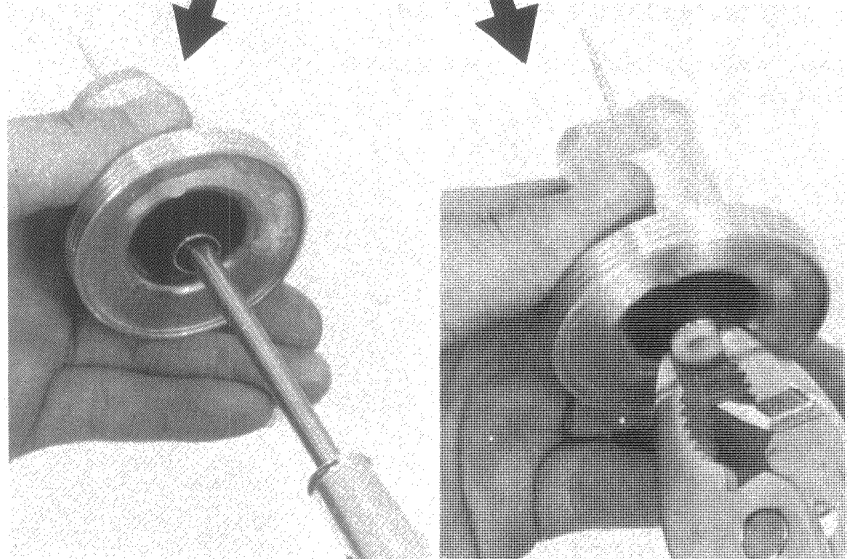
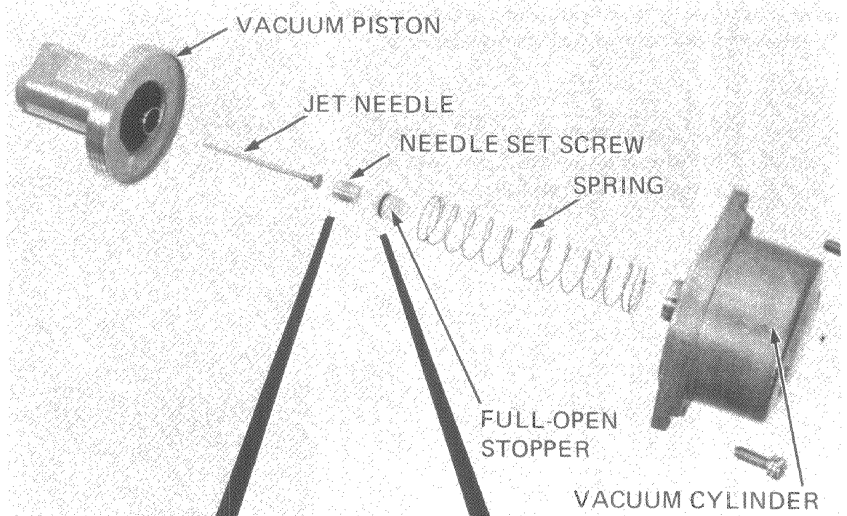

Remove the air jet cover.

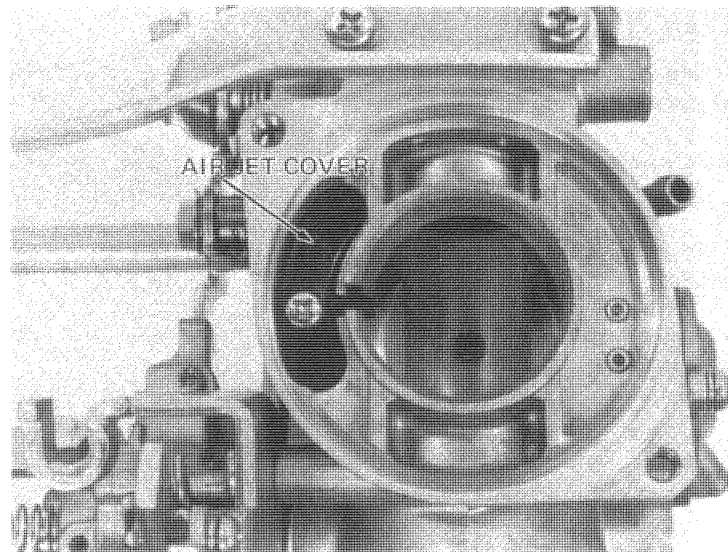



FUEL SYSTEM

Blow open the primary main air jet, secondary air jet, and slow air jet, with compressed air.

NOTE

Never clean carburetor jets with wire or drills. This will enlarge the openings and result in excessive fuel consumption.

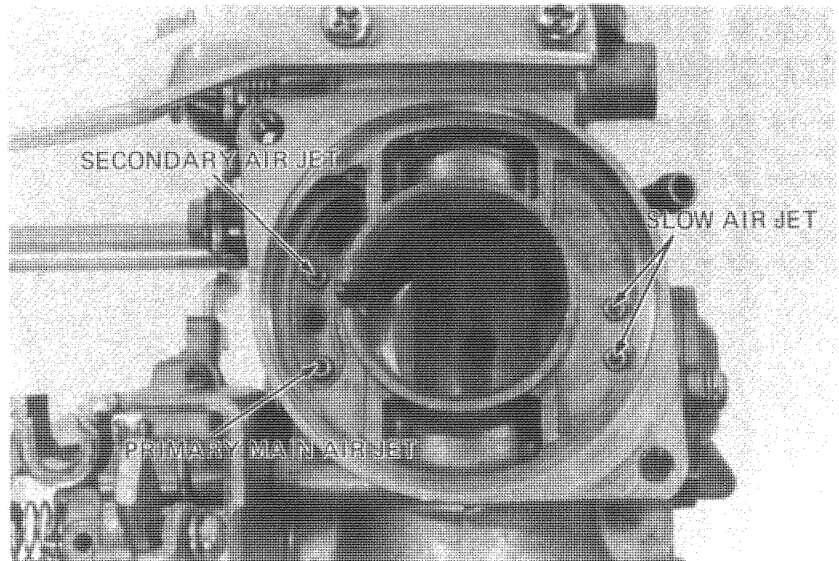

● **VACUUM PISTON INSPECTION**

Check the vacuum piston for free movement in the cylinder.

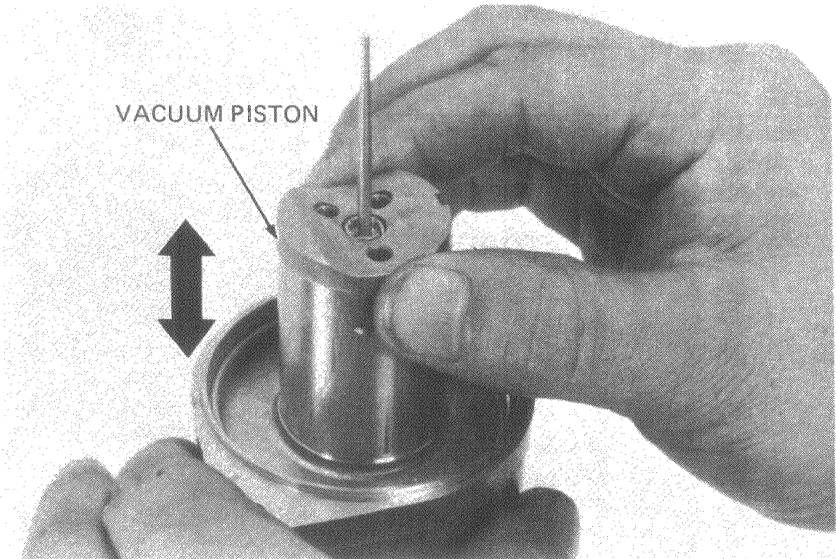

FLOAT CHAMBER DISASSEMBLY

- Remove the float chamber body.
- Remove the secondary main jet and jet needle holder.
- Remove the slow air jet plug.

NOTE

Do not try to remove the slow air jet. It is a press fit.

- Remove the primary main jet.
- Remove the pilot screw.

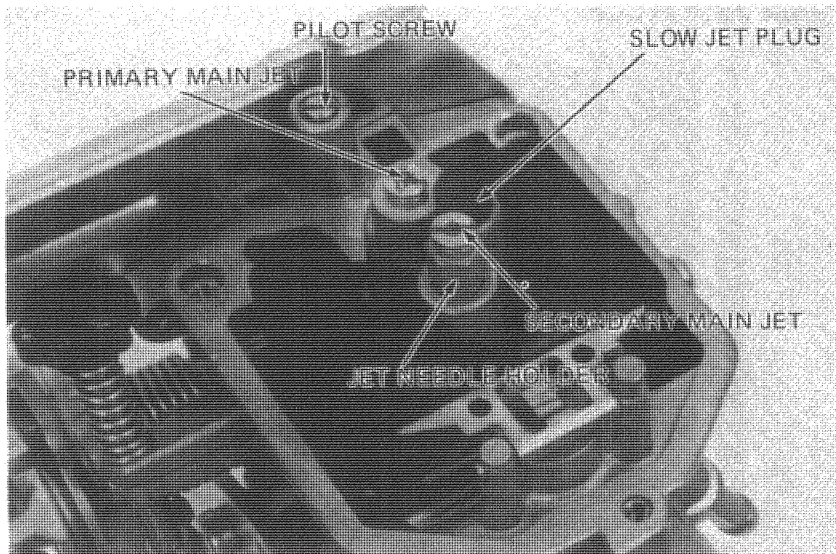



Remove the primary nozzle.

NOTE

Do not try to remove the slow air jet.
It is a press fit.

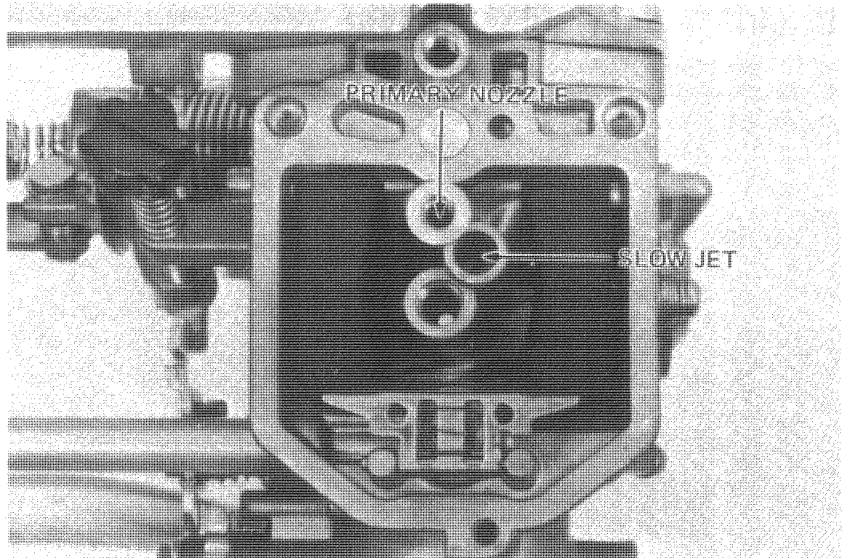

Remove the float arm pin using a needle nose plier.
Remove the float and float valve.

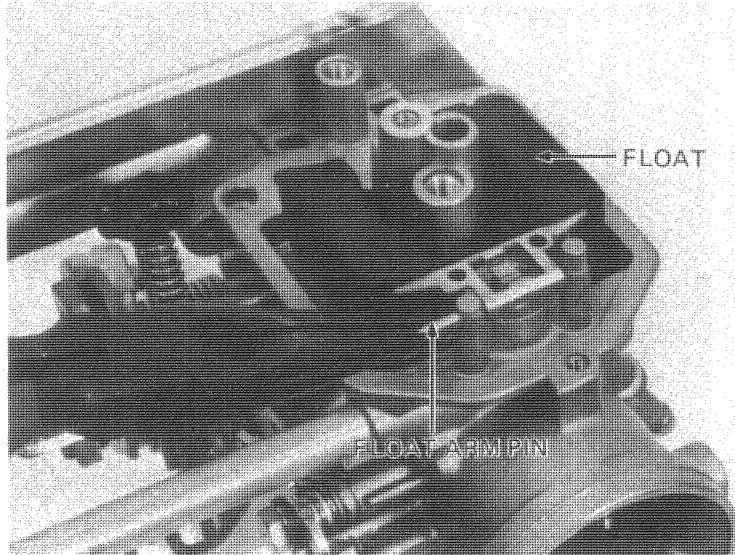

Inspect the float valve and seat for deposits,
grooves or other damage.

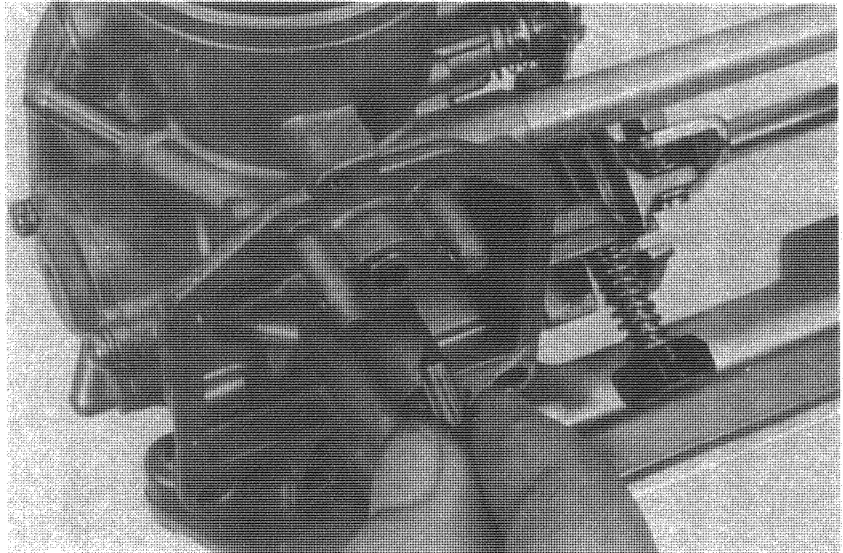



FUEL SYSTEM

AIR CUTOFF VALVE DISASSEMBLY

Remove the air cutoff valve cover and spring.
Remove the diaphragm.
Remove the O-ring.

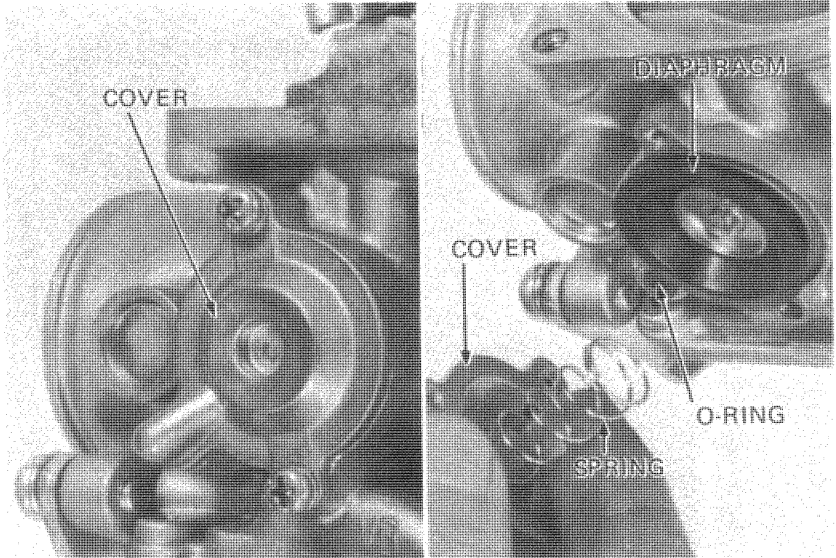

Inspect the air hoses and diaphragm for cracks and brittleness.

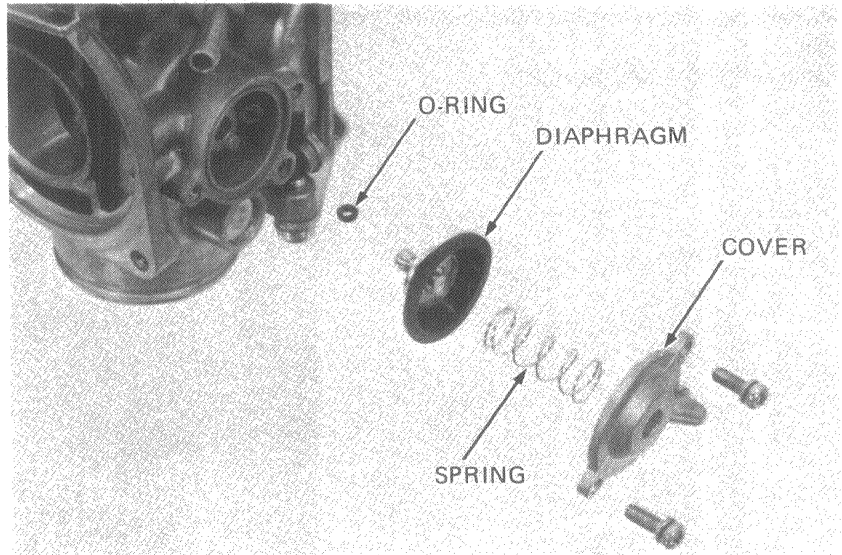

Clean the passages and jets with compressed air.

COMPONENT ASSEMBLY

Assemble the air cutoff valve, float chamber and vacuum cylinder in the reverse order of disassembly. Make sure the O-rings seat in their grooves.

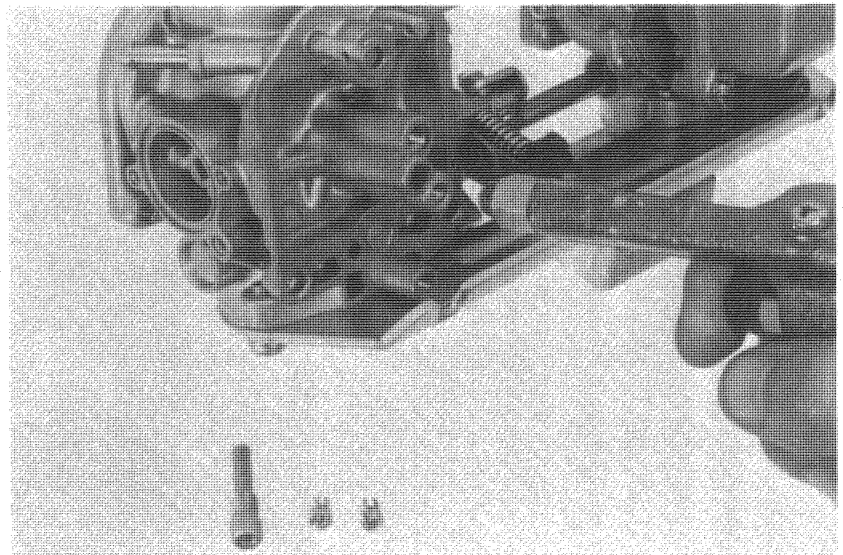



FLOAT LEVEL ADJUSTMENT

Measure the float level.

Adjust the float level by bending the metal float arm with needle-nose pliers.

FLOAT LEVEL: 15.5 mm (0.61 in)

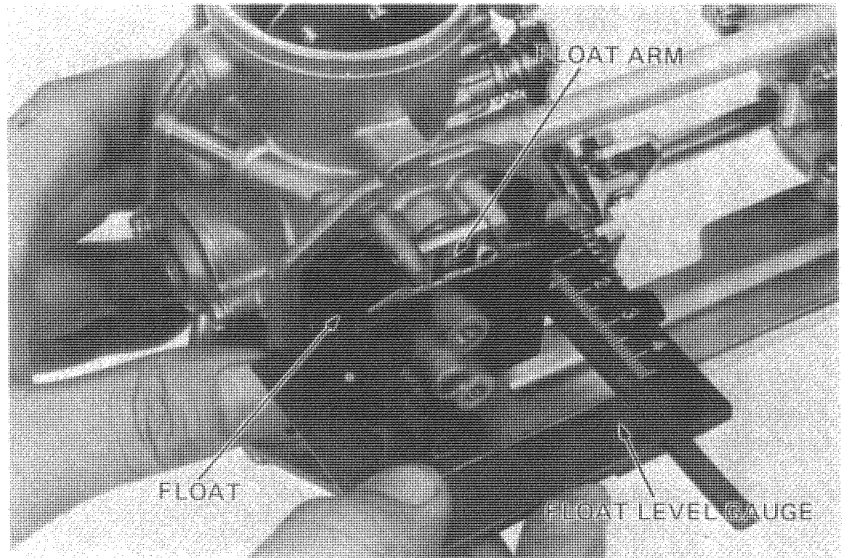

FAST IDLE ADJUSTMENT

FAST IDLE: 1,500-2,500 rpm

If adjustment of the fast idle is necessary, remove the carburetor, and close the throttle valve by turning the throttle stop screw out.

Adjust by opening or closing the fork end of the fast idle lever until the clearance between the fast idle lever and throttle drum is about 0.8 mm (0.047 in).

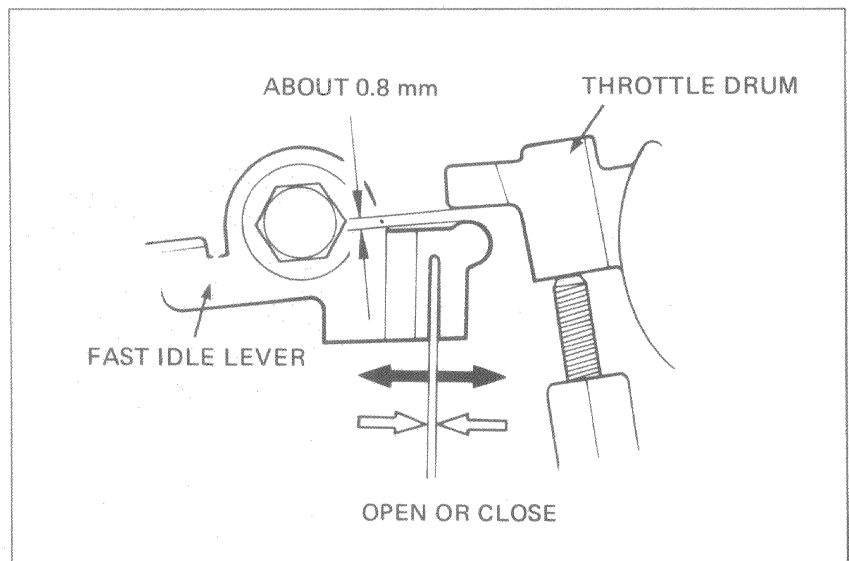

CARBURETOR INSTALLATION

Installation is the reverse order of removal.

NOTE

Do not interchange the OPEN and RETURN throttle cables.

After installation, perform the following adjustments.

- Throttle grip free play (Page 3-5).
- Carburetor synchronization (Page 3-7).
- Idle speed adjustment (Page 3-6).
- Pilot screw setting and adjustment (Page 4-10).

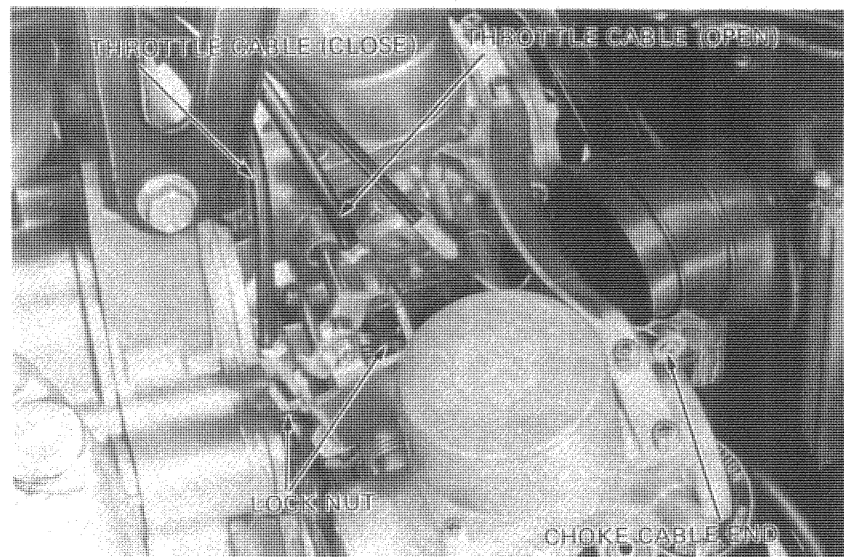

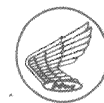

PILOT SCREW INITIAL SETTING

NOTE

The pilot screw is factory pre-set. Do not adjust unless the carburetor is overhauled.

Turn the pilot screw clockwise until it seats lightly and back it out to the specification. This is a preliminary setting prior to the final pilot screw adjustment.

PILOT SCREW INITIAL OPENING: 2 turns

CAUTION

Damage to the pilot screw seat will occur if the pilot screw is tightened.

PILOT SCREW ADJUSTMENT

NOTE

Use a tachometer with graduations of 100 rpm.

1. Warm up the engine to operating temperature.
Stop and go driving for approximately 10 minutes is sufficient.
2. Attach a tachometer.
3. Adjust the idle speed with the throttle stop screw.
IDLE SPEED: 1,100 ± 100 rpm
4. Turn the pilot screw in or out to obtain the highest engine speed.
5. Readjust the idle speed with the throttle stop screw.
6. Turn the pilot screw in gradually until the engine speed drops 100 rpm.

NOTE

If the pilot screw seats before lowering the engine speed 100 rpm, continue to step 7.

7. Turn the pilot screw 1 turns open from the position obtained in step 6.
8. Readjust the idle speed with the throttle stop screw.

NOTE

Perform steps 4 thru 8 for the remaining carburetor.

HIGH ALTITUDE ADJUSTMENT

The carburetor idle speed may have to be re-adjusted for high altitude riding above 2,000 m (6,500 ft).

IDLE SPEED: 1,100 ± 100 rpm

NOTE

Readjust the pilot screw if the engine idles rough, misses or stalls.

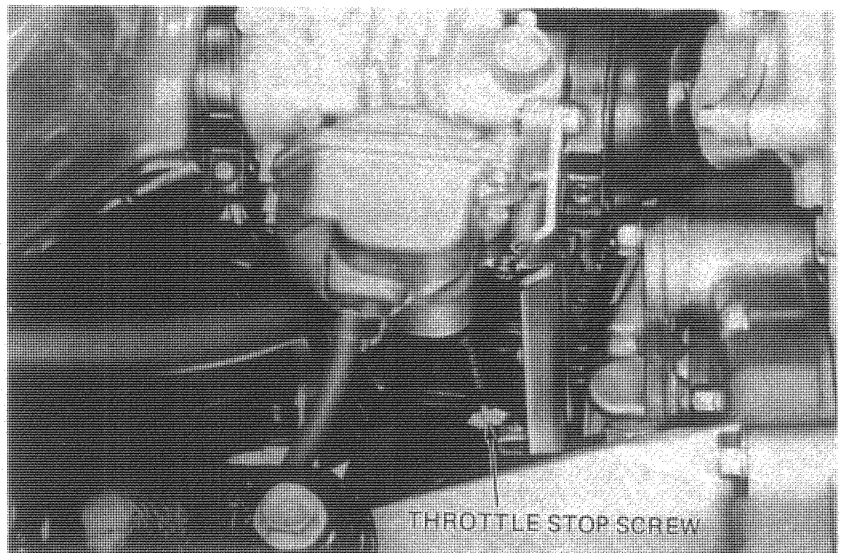
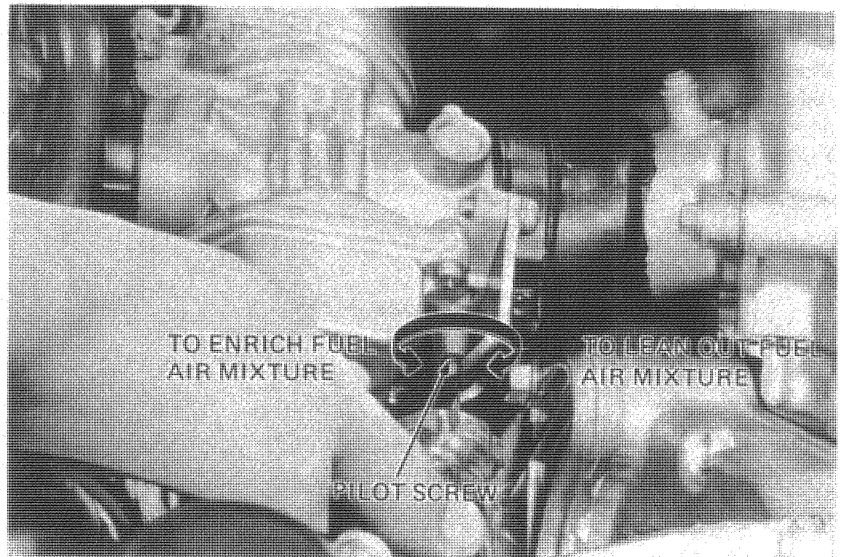



FUEL TANK

WARNING

Keep gasoline away from open flames or sparks.
Wipe up spilled gasoline at once.

Check that fuel is flowing out of the fuel valve freely. If the fuel flow is restricted, clean the fuel strainer.

NOTE

Do not overtighten the fuel valve lock nut.
Make sure there are no fuel leaks.

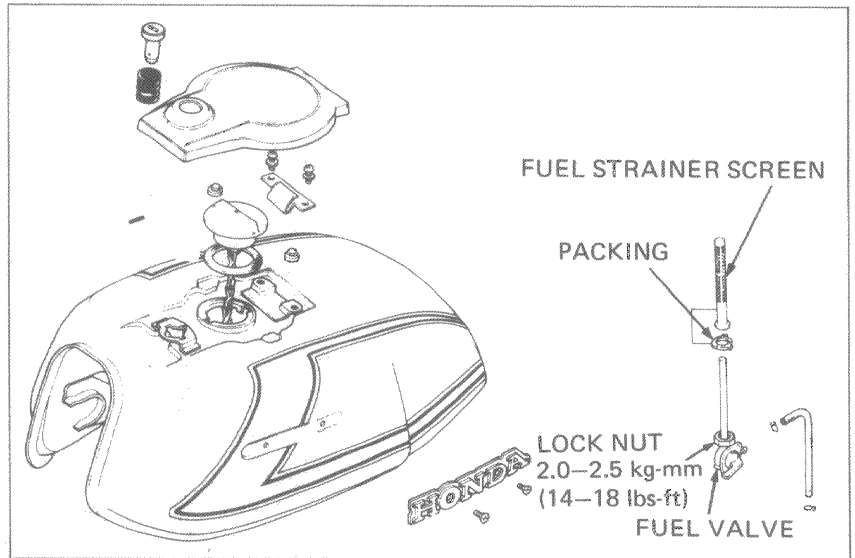

AIR CLEANER CASE

• AIR CLEANER CASE REMOVAL

Disconnect the taillight wires.
Remove the hand rail, cowl and rear fender.

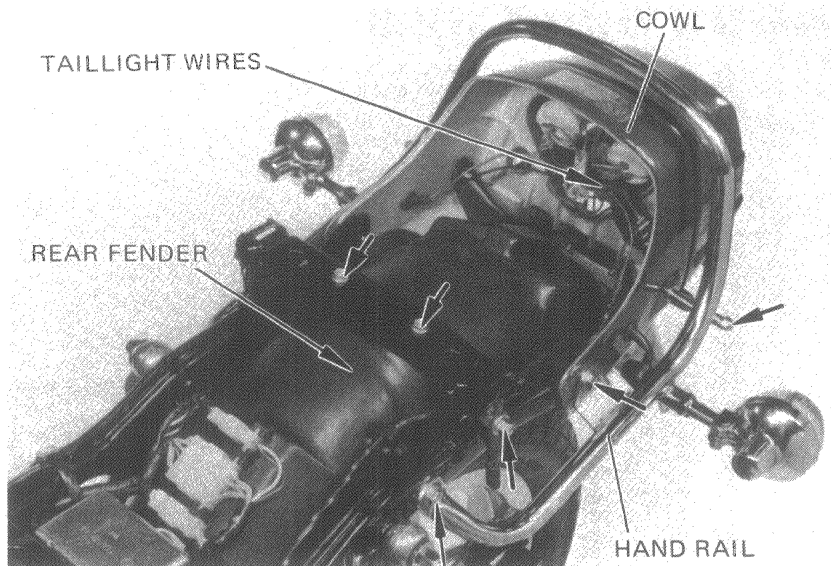

Remove the battery.
Remove the starter magnetic switch and regulator/rectifier.
Remove the carburetor spacer band.

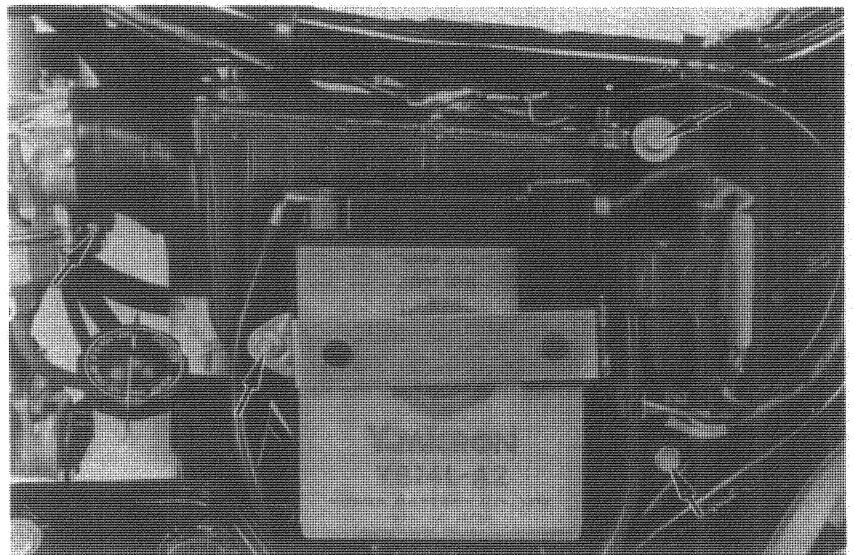



FUEL SYSTEM

Remove three bolts attaching the air cleaner plate, and pull the plate down.
Remove the C.D.I. unit.
Remove the air cleaner mounting bolt from under the C.D.I. unit.
Remove the air cleaner from the right.

NOTE

Installation of the air cleaner is the reverse of removal.

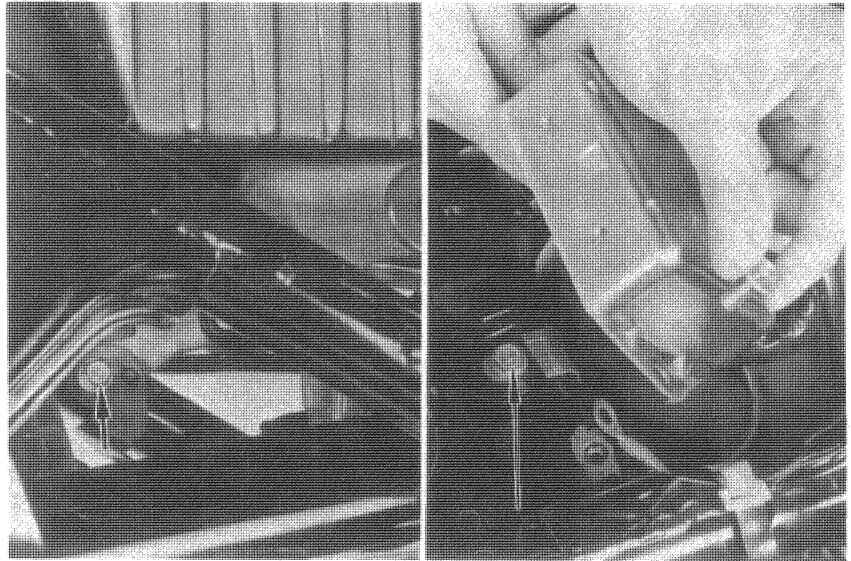

CRANKCASE BREATHER SYSTEM

NOTE

Check that the breather tube is not clogged or collapsed.

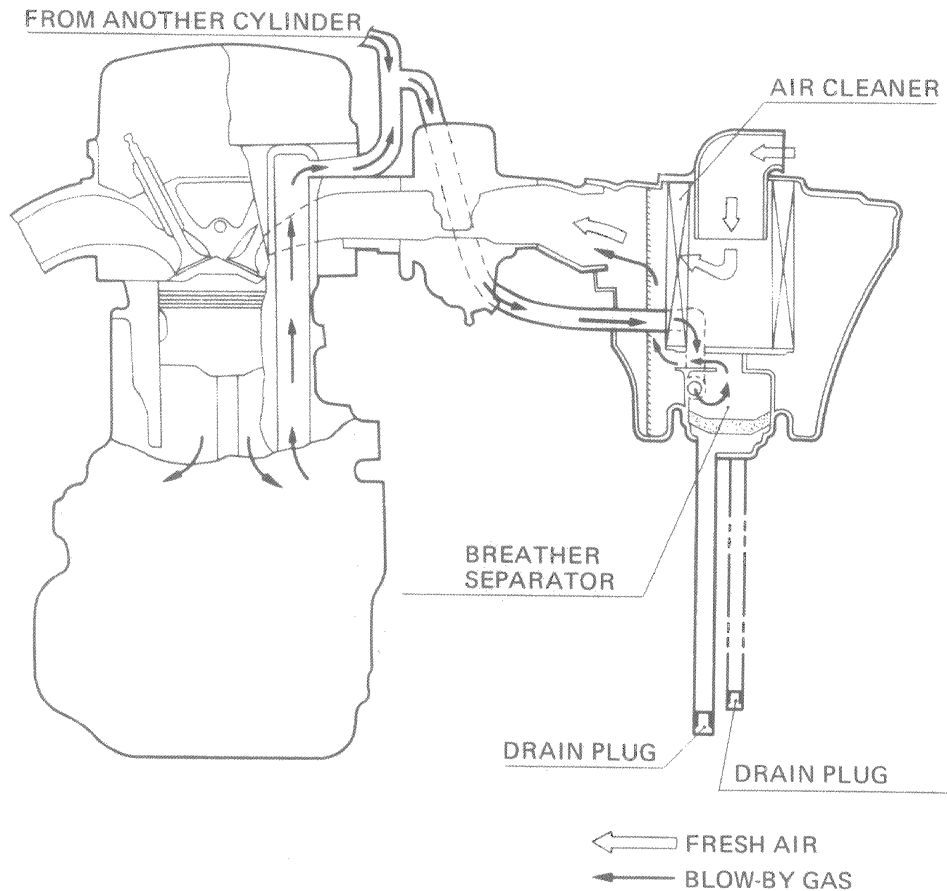



HONDA
CX500

MEMO

