



9. COOLING SYSTEM

| | | | |
|---------------------|------|--------------------------|------|
| SERVICE INFORMATION | 9- 1 | WATER PUMP DISASSEMBLY | 9- 5 |
| TROUBLESHOOTING | 9- 1 | WATER PUMP ASSEMBLY | 9- 6 |
| SYSTEM TESTING | 9- 2 | THERMOSTAT INSTALLATION | 9- 9 |
| COOLANT REPLACEMENT | 9- 3 | COOLING FAN INSTALLATION | 9- 9 |
| THERMOSTAT REMOVAL | 9- 3 | RADIATOR INSTALLATION | 9-10 |
| COOLING FAN REMOVAL | 9- 5 | | |

SERVICE INFORMATION

• WORKING PRACTICE

To service the water pump seal, it is necessary to remove the rear engine cover. All the other cooling system services can be made with the engine in the frame.

Do not remove the radiator cap when the engine is hot. The coolant is under pressure and severe scalding could result. The engine must be cool before servicing the cooling system.

Avoid spilling coolant on painted surfaces. After servicing the system, check for leaks with a radiator tester.

• SPECIAL TOOLS

- Special tool
 - MECHANICAL SEAL DRIVER ATTACHMENT
07945-4150200
- Common tools
 - FLYWHEEL ROTOR PULLER
07733-0010000
 - DRIVER HANDLE (A)
07749-0010000
 - COOLING SYSTEM TESTER
M988X-525-XXXXX

• SPECIFICATIONS

| | |
|-------------------------------------|--|
| Radiator cap relief pressure | 0.75-1.05 kg/cm ² (10.7 - 14.9 psi) |
| Freezing point (Hydrometer test): | 55% Distilled water + 45% ethylene glycol: -32°C (-25°F) 50% Distilled water + 50% ethylene glycol: -37°C (-34°F) 45% Distilled water + 55% ethylene glycol: -44.5°C (-48°F) |
| Coolant capacity: | |
| Radiator and engine | 1.8 liters (1.9 U.S. qt) |
| Reserve tank | 0.2 liters (0.21 qt.) |
| Total system | 2.0 liters (2.16 qt.) |
| Thermostat | Begins to open: 80° to 84°C (176° to 183°F) Fully open: 93° to 97°C (199° to 205°F) Valve lift: Minimum of 8 mm at 95°C (0.315 in. at 203°F) |
| Boiling point (with 50-50 mixture): | Unpressurized: 107.7°C (226°F) Cap on, pressurized: 125.6°C (258°F) |

TROUBLESHOOTING

Engine Temperature Too High

- Faulty temperature gauge or gauge sensor
- Thermostat stuck closed
- Faulty radiator cap
- Insufficient coolant
- Passages blocked in radiator, hoses, or water jacket
- Fan blades bent

Engine Temperature Too Low

- Faulty temperature gauge or gauge sensor
- Thermostat stuck open

Coolant Leaks

- Faulty pump oil seal
- Deteriorated O-rings



COOLING SYSTEM

SYSTEM TESTING

• **COOLANT**

Test the coolant mixture with an antifreeze tester. For minimum corrosion protection, a 50–50% solution of ethylene glycol and distilled water is recommended.



• **RADIATOR CAP INSPECTION**

Pressure test the radiator cap. Replace the radiator cap if it does not hold pressure, or if relief pressure is too high or too low. It must hold specified pressure for at least six seconds.

NOTE

Before installing the cap on the tester, apply water to the sealing surfaces.

RADIATOR CAP RELIEF PRESSURE:
 $0.9 \pm 0.15 \text{ kg/cm}^2$ ($12.8 \pm 2.1 \text{ Psi}$)

COOLING SYSTEM TESTER
M988X-525-XXXXX

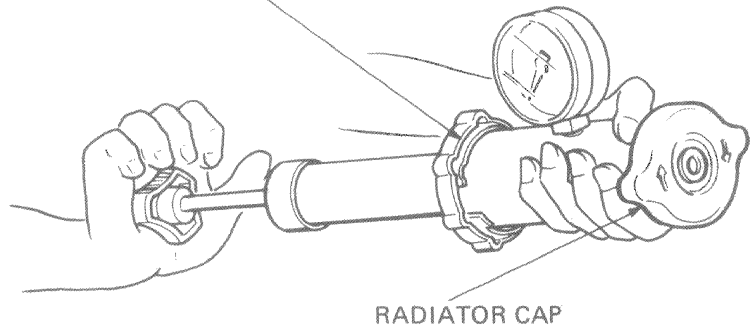

Pressurize the radiator, engine and hoses, and check for leaks.

CAUTION

*Excessive pressure can damage the radiator.
Do not exceed 1.05 kg/cm^2 (14.9 Psi)*

Repair or replace components if the system will not hold specified pressure for at least six seconds.

COOLING SYSTEM TESTER
M988X-525-XXXXX

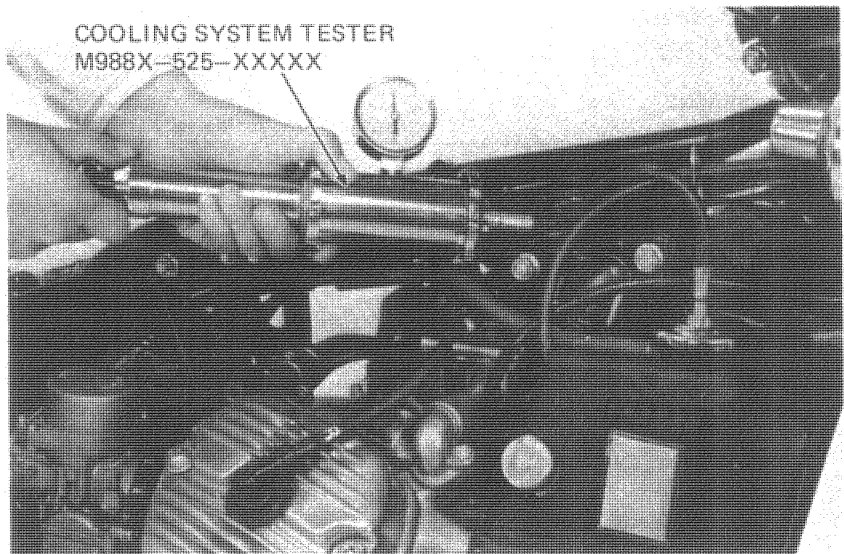



COOLANT REPLACEMENT

WARNING

Engine must be cool before servicing the cooling system, or severe scalding may result.

- Remove the seat and fuel tank.
- Remove the radiator cap.
- Remove the radiator cover grommets and 6 mm screws.
- Remove the radiator cover.

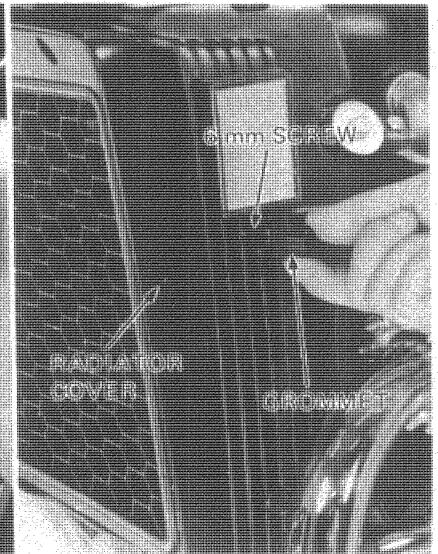
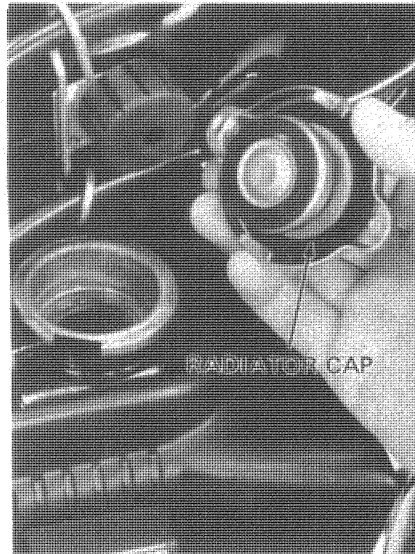

- Remove the radiator drain plug, and drain the coolant (about 1.4 liters).
- To drain coolant from the cylinders, remove the cylinder drain plugs (about 0.4 liters).
- Replace the cylinder and radiator drain bolt.

CAUTION

Do not overtighten the radiator drain plug.

Fill the system with a 50–50 mixture of distilled water and ethylene glycol.

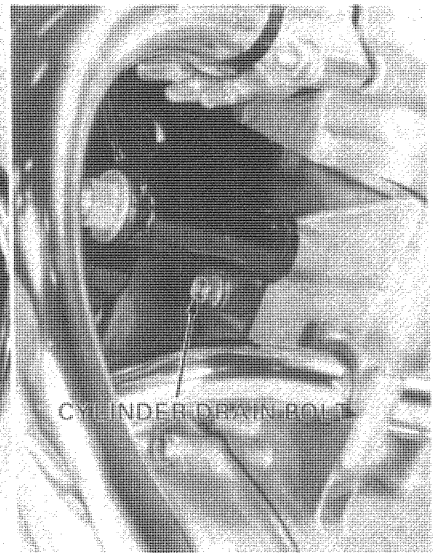

THERMOSTAT REMOVAL

- Remove the seat and fuel tank.
- Remove the coolant drain plug, and drain the coolant.
- Disconnect the bypass hose.
- Disconnect the temperature unit and oil pressure gauge wires.
- Remove the air spoiler.

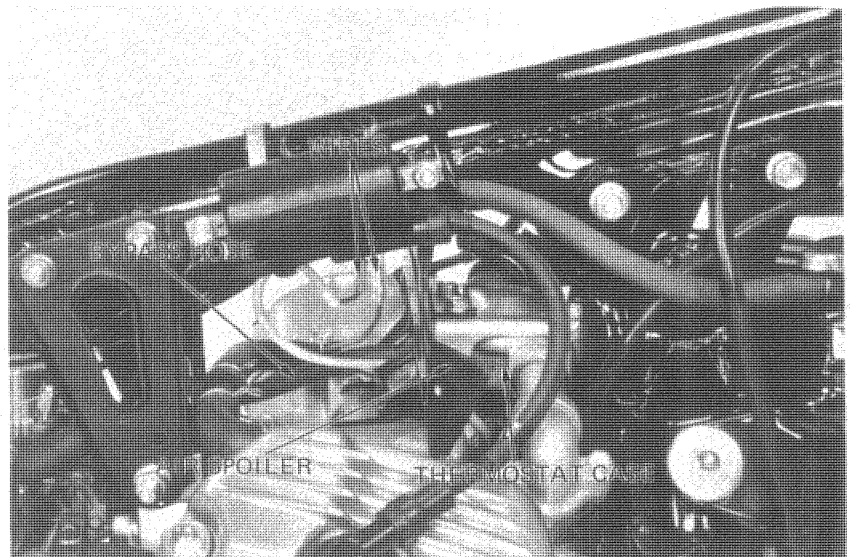



COOLING SYSTEM

Loosen the radiator hose band and pull the hose off the thermostat cover.
Remove the thermostat bracket bolts.
Remove the thermostat assembly.

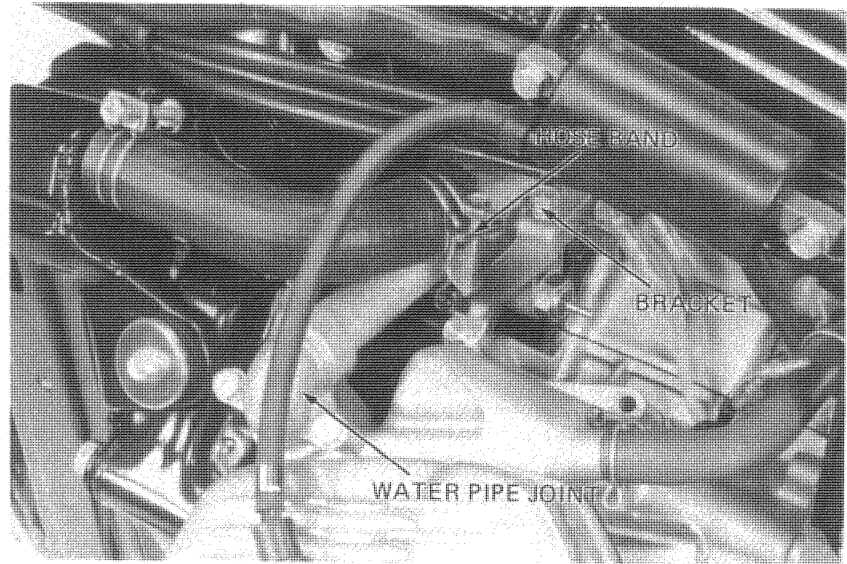

Separate the thermostat bracket from the thermostat housing.
Remove the thermostat cover and take out the thermostat.
Disconnect the water pipe.
Remove the water temperature unit.

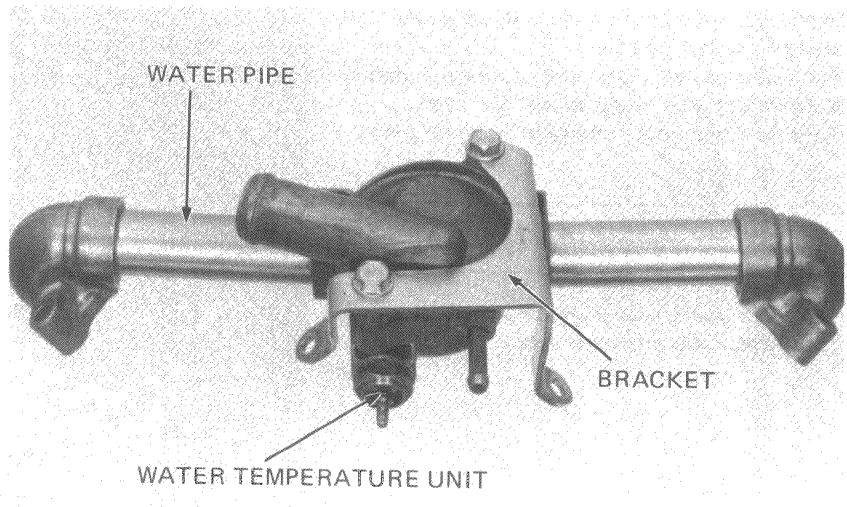

● TEMPERATURE UNIT INSPECTION

Suspend the unit in oil and measure the resistance through the unit as the oil heats.

| | | | | |
|-------------|---------|--------|--------|--------|
| Temperature | 60°C | 85°C | 110°C | 120°C |
| | 140°F | 185°F | 230°F | 248°F |
| Resistance | 104.0 Ω | 43.9 Ω | 20.3 Ω | 16.1 Ω |

Do not let the unit or thermometer touch the pan or false readings will result.

WARNING

Wear gloves and eye protection.

NOTE

Oil must be used as the heated liquid to check operation above 100°C (212°F).

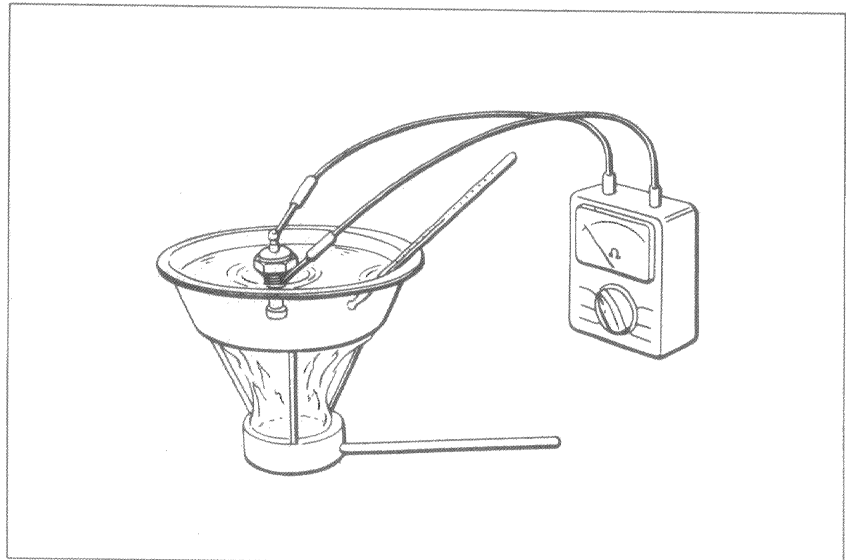



● **THERMOSTAT INSPECTION**

Inspect the thermostat visually for damage. Suspend the thermostat in hot water to check operation.

Do not let the thermostat or thermometer touch the pan or false readings will result.

Technical Data

| | |
|---------------|----------------------------|
| Start to open | 80° to 84°C (176° – 183°F) |
| Fully open | 95°C (203°F) |
| Valve lift | 8 mm minimum (0.31 in) |

NOTE

- Replace thermostat if valve stays open at room temperature, or if it responds at temperatures other than those specified.
- Valve lift must be checked by applying heat for five minutes.

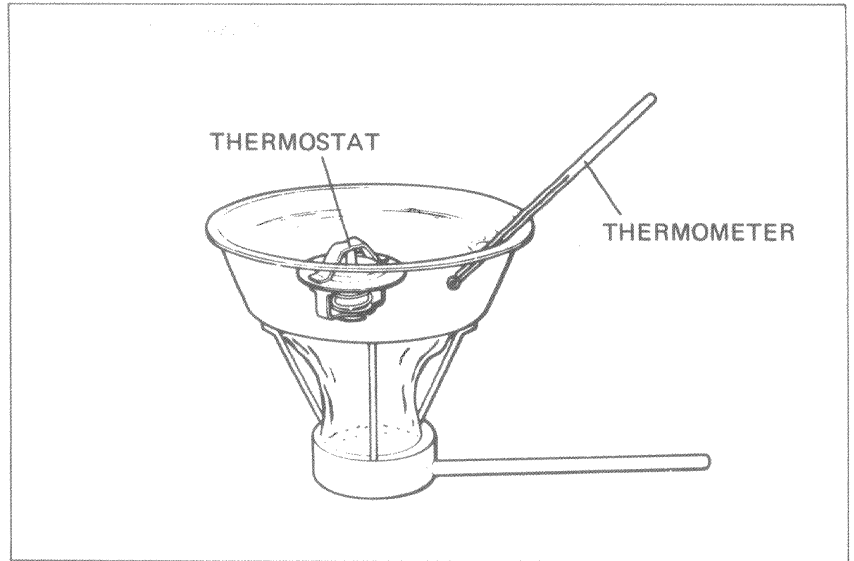

COOLING FAN REMOVAL

- Remove the seat and fuel tank.
- Remove the radiator (Page 5–6),
- Remove the crankshaft hole cap and hold the crankshaft.
- Remove the fan bolts.
- Remove the fan.

FLYWHEEL ROTOR PULLER

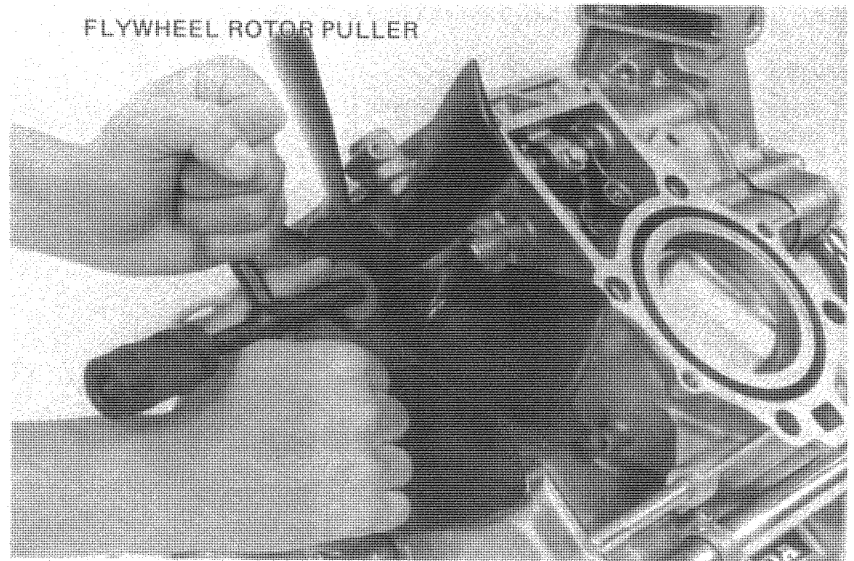

WATER PUMP DISASSEMBLY

- Remove the engine from the frame (Page 5–2).
- Disconnect the water pipes.
- Remove the water pump cover.

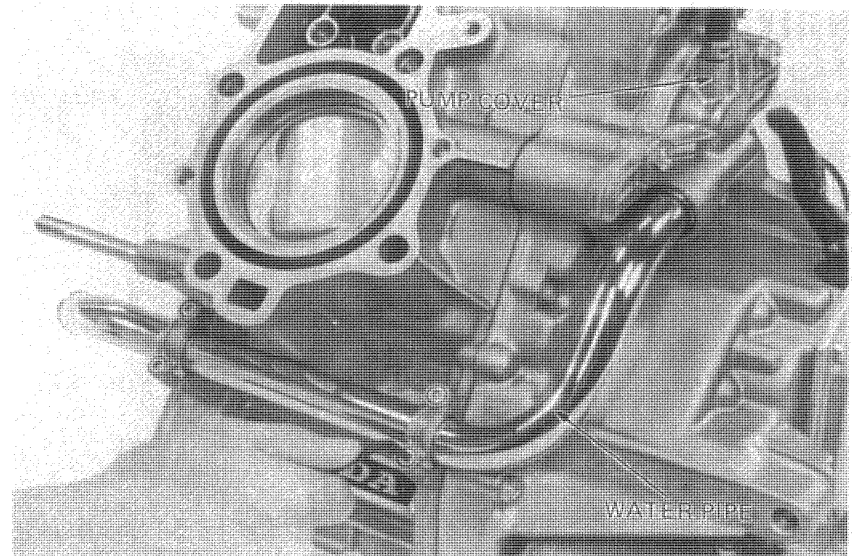



COOLING SYSTEM

- Remove the cap nut, copper washer and impeller.
- Remove the starter motor.
- Remove the rear cover bolts.
- Remove the rear cover.

NOTE

Inspect the impeller for wear or damage.

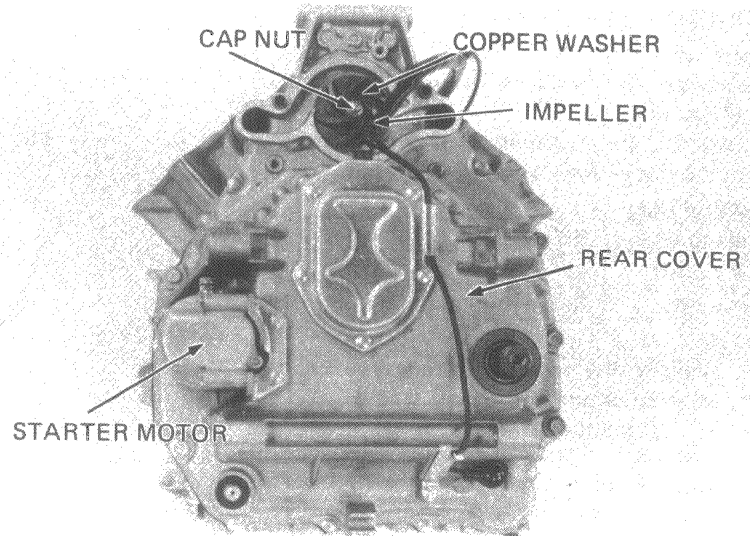

Drive the mechanical seal out from the inside.

NOTE

Avoid damaging the rear cover when driving the seal out.

Inspect the mechanical seal for damage or evidence of deterioration.

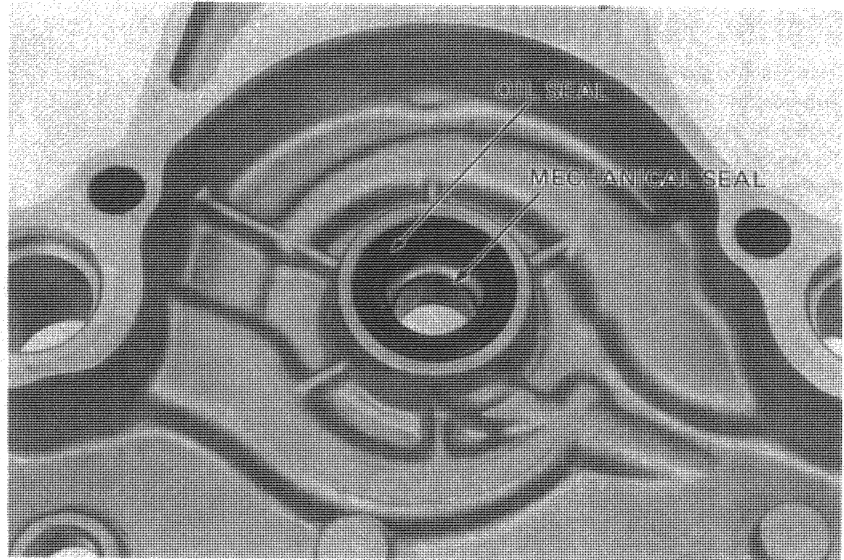

WATER PUMP ASSEMBLY

Apply a thin coat liquid sealant to the outer-periphery of the mechanical seal.

NOTE

Check that the water pump drain hole is clear.

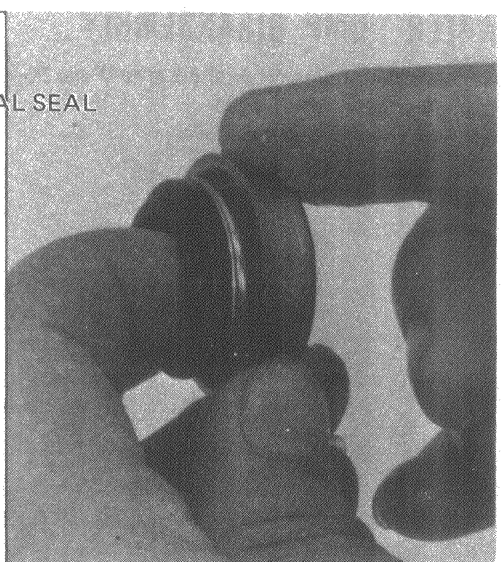
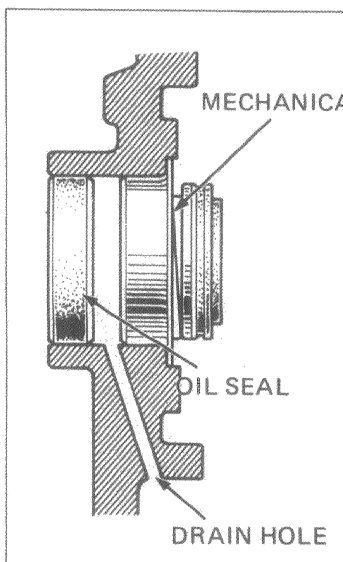



Drive the mechanical seal into position in the rear cover with the mechanical seal driver attachment, bearing driver handle and mechanical seal pilot.

NOTE

- Assemble the driver as follows:
Install the seal driver attachment to the driver handle. Place the mechanical seal into the attachment and hold it in place by screwing in the seal pilot. (See the illustration)
- Drive in the seal squarely.
- Remove the seal pilot after driving in the seal.

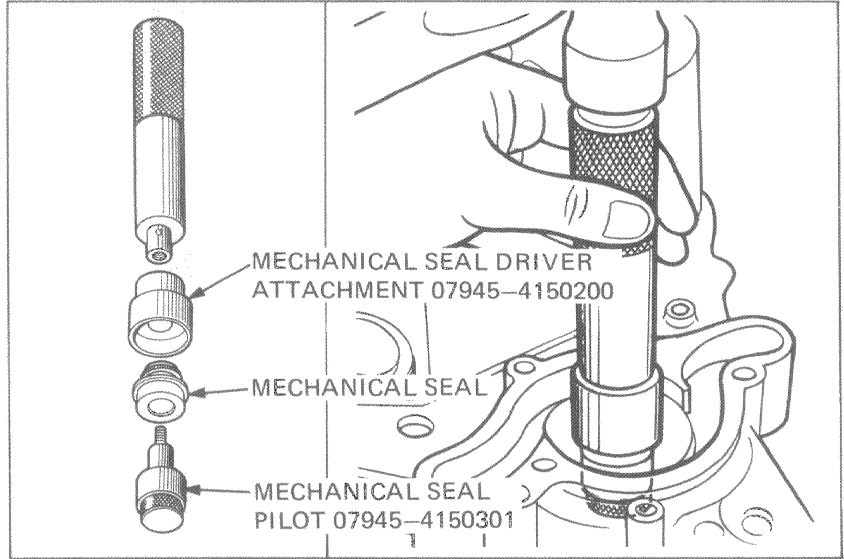

Install the collars, O-rings, dowel pins and rear cover gasket.

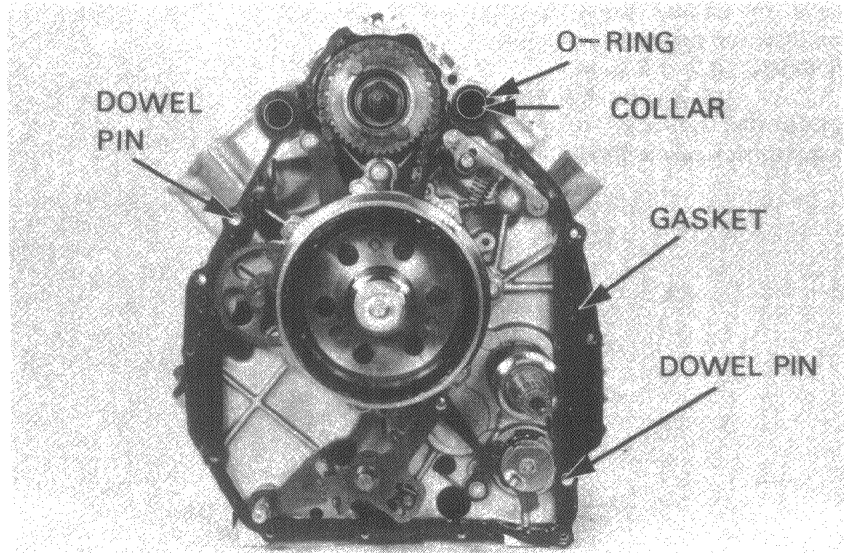

Install the rear cover and torque the bolts.

TORQUES:

- 6 mm bolts: 0.8–1.2 kg-m (6–9 ft-lbs)
- 8 mm bolts: 1.8–2.5 kg-m (13–18 ft-lbs)

Install the starter motor.

NOTE

Engage the starter drive gear with the reduction gear before tightening the cover.

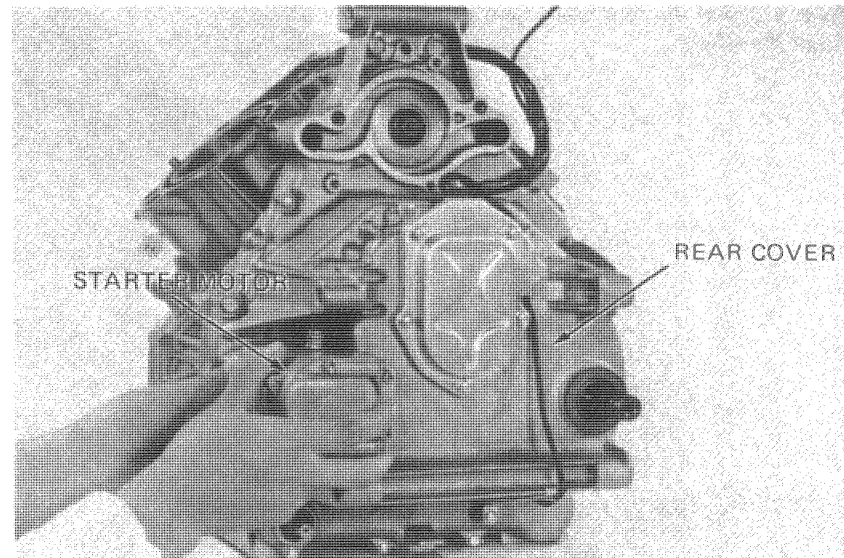



COOLING SYSTEM

Install the seal rubber and seal washer in the impeller and apply soapy water to the sliding surfaces.

NOTE

- Dip the seal rubber to facilitate installation.
- Check that the seal rubber is positioned properly.

Slide the collar into the impeller and install the impeller.

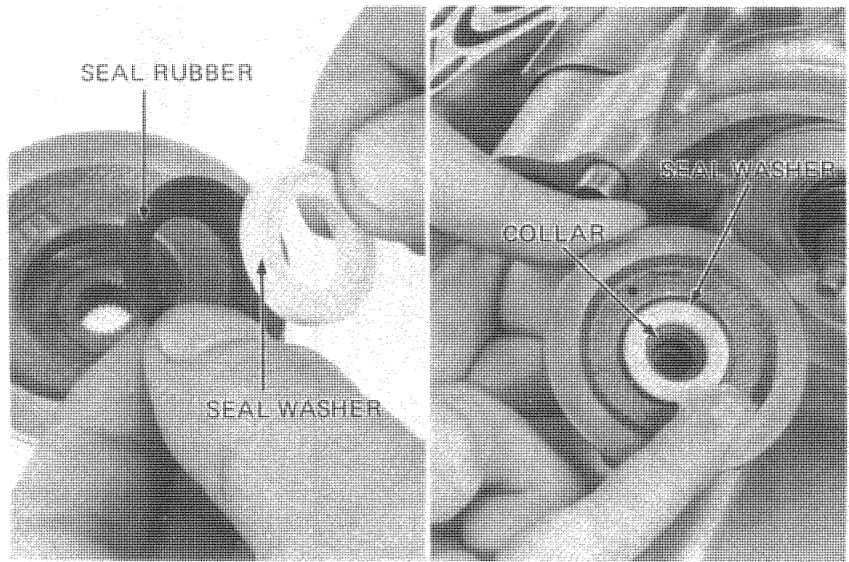

Install the copper washer and cap nut on the camshaft and torque the cap nut.

TORQUE: 0.8–1.2 kg-m
(6–9 ft-lbs, 52–104 in-lbs)

Rotate the crankshaft to make sure that the pump turns freely without binding.

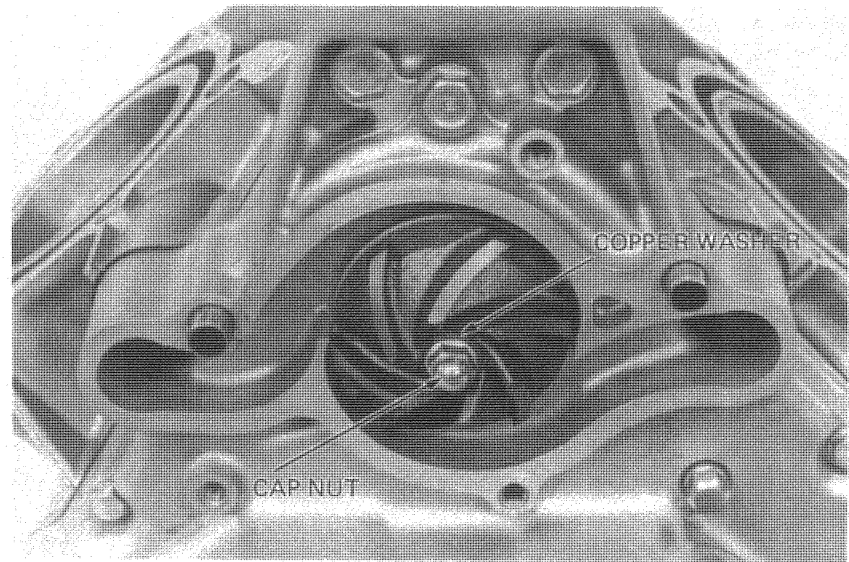

Place a gasket on the water pump cover and install the cover.

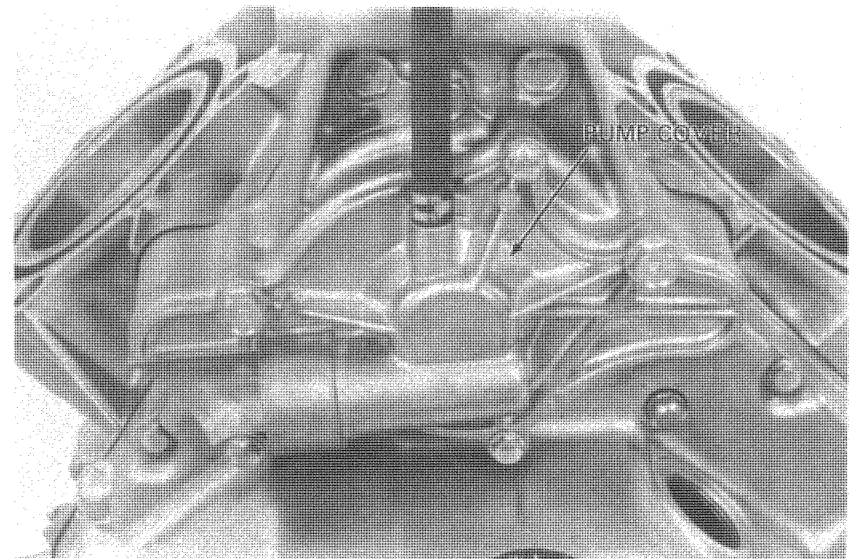



Slip on the O-ring on the water pipe and press the water pipe into place in the pump rear cover.

NOTE

Make sure that the O-ring is properly seated.

Install the water pipe holders.

NOTE

Torque the upper bolts ① first, then torque the lower bolts ②.

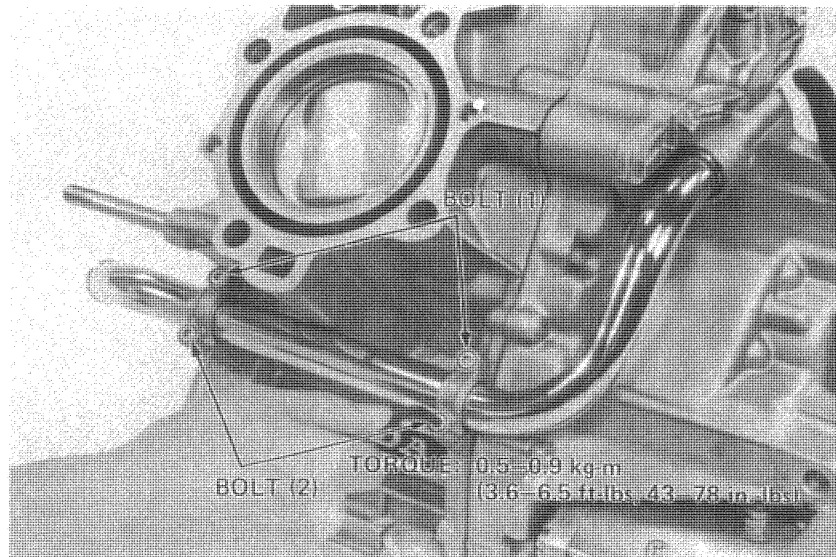

THERMOSTAT INSTALLATION

Insert the thermostat into the thermostat case. Install a new O-ring on the thermostat case and attach the thermostat cover and bracket. Install the temperature unit, slide new O-rings onto the water pipes, press the water pipes into the thermostat case and elbows.

NOTE

Check that the O-rings are not dislodged.

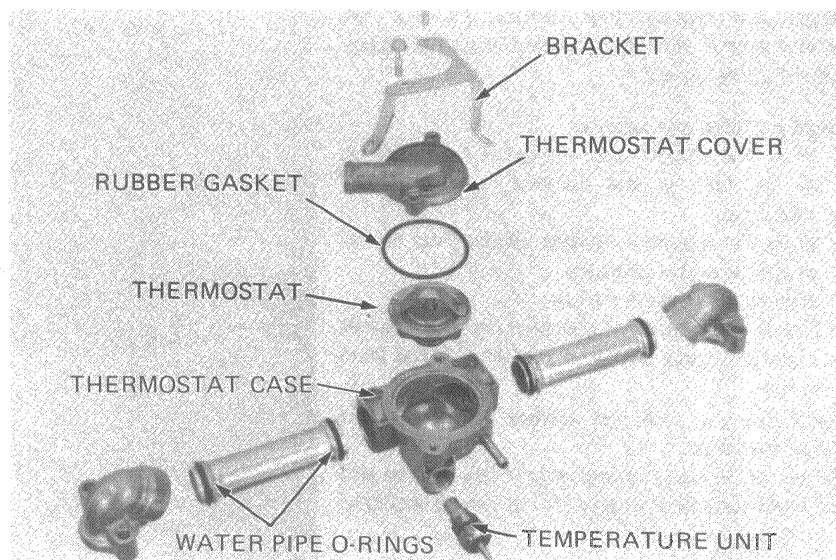

Install the thermostat assembly.
Install the air spoiler.
Connect the water bypass hose.

COOLING FAN INSTALLATION

Install the cooling fan.
Install the radiator.
Install the air spoiler.

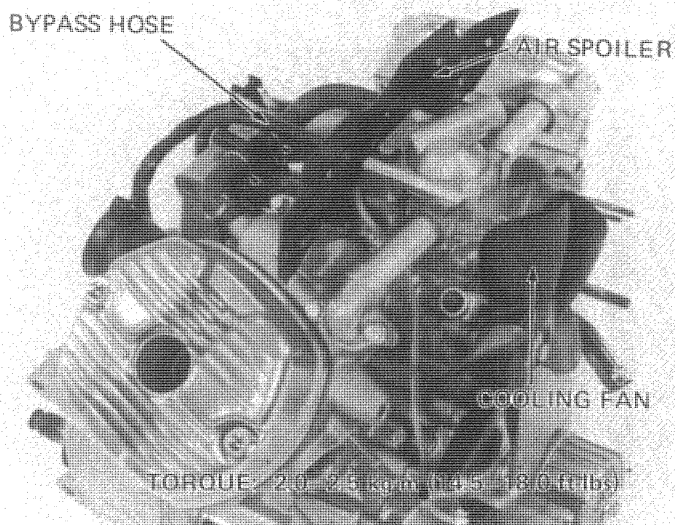



RADIATOR INSTALLATION

Torque the radiator drain bolt.

TORQUE: 0.15–0.30 kg-m (13–26 in-lbs)

Install the radiator upper and under hoses on the thermostat cover and water pipe.

Tighten the radiator mount bolts (6 mm). Tighten the radiator upper and under hose bands.

Install the radiator cover.

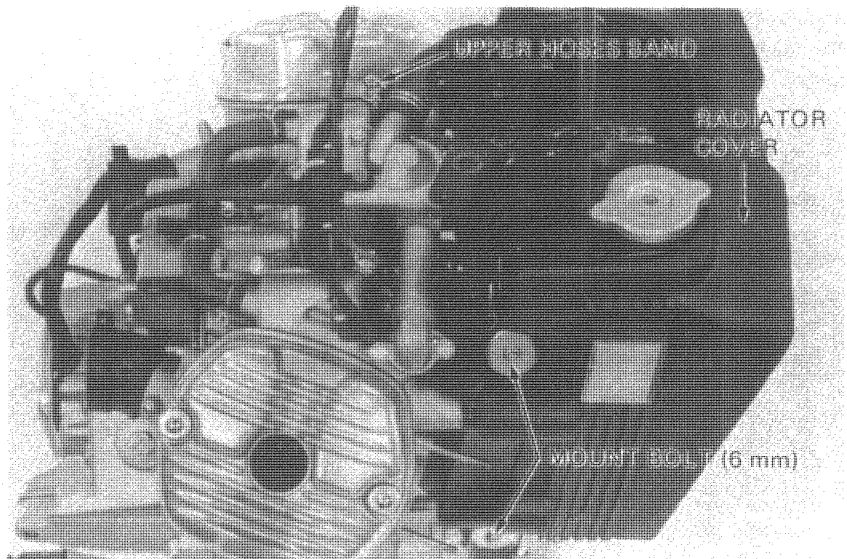

Install the engine (See Section 5). Fill the system with a 50–50 mixture of distilled water and ethylene glycol.

Bleed air from the radiator

- Start the engine and run until there are no air bubbles in the coolant, and the level stabilizes.
- Stop the engine and add coolant up to the proper level if necessary.
- Reinstall the radiator cap.
- Check the level of coolant in the reserve tank and raise to the correct level if the level is low.

Pressurize the radiator, engine and hoses and check for leaks.

Repair or replace components if the system will not hold specified pressure for at least 6 seconds.

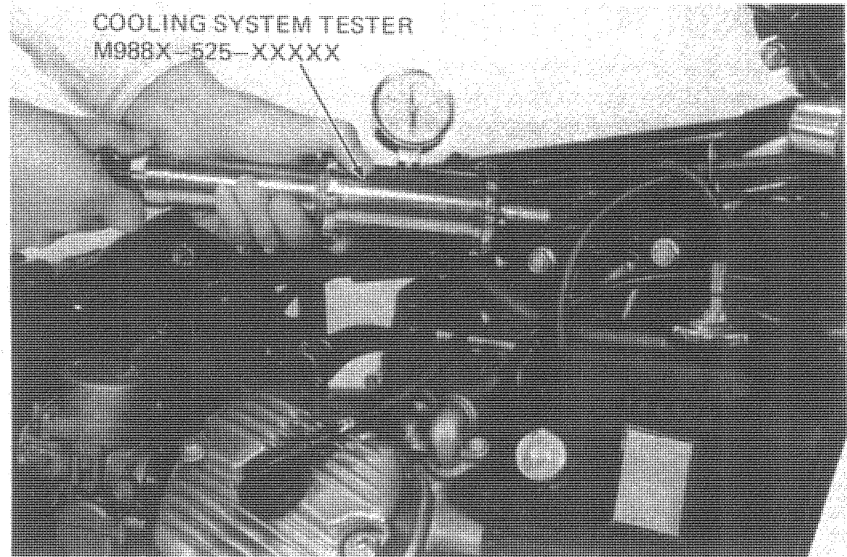

CAUTION

Excessive pressure can damage the radiator. Do not exceed 1.05 kg/cm² (14.9 psi).



HONDA
CX500

MEMO

